

Toilets. Basins. Baths. Tapware. Accessories. Saunas. Showers.

metrix.co.nz

Paini

Duravit

Valsir

Kaldewei

Inda

Dornbracht

Marblo

Almar

Silfra

Cristina



SPARE PARTS.

Revised June 2022



Proud
subsidiary of **NZPM**co-operative

CONTENTS

2	Duravit Outlet and Inlet Valve	33	Paini Hand Sprays
3	Duravit Miscellaneous	34	Paini Handles
4	Duravit Seats	35	Paini Handles continued
5	Duravit Seats continued	36	Paini Handles continued
6	Duravit Seat Buffers	37	Paini Faceplates
7	Duravit Seat Hinges	38	Paini Faceplates continued
8	Duravit Seat hinges continued	39	Paini Fixings
9	Valsir Push Panel Images	40	Paini Miscellaneous
10	Valsir Push Panel Images continued	41	Paini Miscellaneous continued
11	Valsir Tropea 2 Breakdown	42	Paini Shower Parts
12	Valsir Tropea 2 Pneumatic Breakdown	43	Nikles Shower Parts
13	Valsir Tropea 3 Breakdown	44	Silfra Cartridges
14	Valsir Tropea S Breakdown	45	Silfra Cartridges continued
15	Valsir Evolut Breakdown	46	Silfra Bath Wastes
16	Valsir Winner S Breakdown	47	Silfra Pop Up Wastes
17	Valsir Medusa Breakdown	48	Bonimini & Valentin
18	Valsir Rios Breakdown	49	Inda
19	Valsir Egea Breakdown	50	Almar
20	Valsir Outlet & Inlet Valves	51	Dornbracht Cartridges
21	Valsir Tropea 2 & Evolut	52	Dornbracht Miscellaneous
22	Valsir Tropea 2 & Evolut continued	53	Dornbracht Miscellaneous cont
23	Valsir Tropea 3 & Tropea S & Winner S	54	Dornbracht Miscellaneous cont
24	Valsir Medusa & Rios & Egea	55	Dornbracht Spouts
25	Valsir Pneumatic Buttons Spares	56	Vola Spares
26	Valsir Flushpipes & Miscellaneous	57	Kaldewei
27	Valsir Flushpipe & Miscellaneous cont		
28	Paini Cartridges Codes List		
29	Paini Cartridges Codes List		
30	Paini Cartridges Codes List		
31	Paini Cartridges		
32	Paini Cartridges continued		

1



003050100
DURAVIT RAILS FOR SIPHON COVER

2



100180000
FIXINGS FOR 343.55 / 339.55 SEMI RECESSED BASIN

3



100206000
END CAPS & FIXING SET FOR 0030611000 CONSOLE

4



100107000
DURAVIT OVERFLOW CAP

5



0074151000
CHROME PLUG FOR CISTERN

6



0074134900
FLAPPER VALVE

7



1002110000
DURAVIT SOLENOID

8



1003761000
DURAFIX (INVISIBLE FIXING) FOR WALL HUNG PAN

9



B8541
90 DEGREE UNIVERSAL PAN

10



005076
DURAVIT SPACE SAVING SIPHON FOR DURAVIT FURNITURE

11

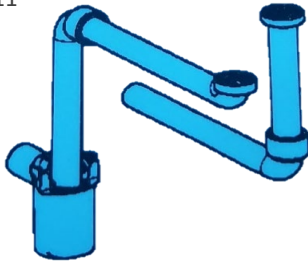

005076
DURAVIT SPACE SAVING SIPHON FOR DURAVIT FURNITURE

12



8990250000
DURAVIT GOOSENECK

13



0067021000
BTW PAN FIXING SET

14



0051120000 DURAVIT HORIZONTAL URINAL SIPHON

15



0050110000
DURAVIT VERTICAL URINAL SIPHON WITH SIPHONIC TRAP

16



695800
DURAVIT 1/2" URINAL INLET SPARGE FOR BACK INLET URINAL (NEW CODE 695800)

17



695100000
BOLTS FOR BASIN (SOLD AS PAIR)

18



005028
DURAVIT FIXINGS FOR STONE COUNTER TOP

19







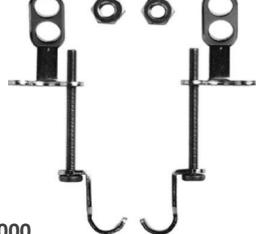















0050000000
BRACKET FOR CORNER BASIN

20



0050000000
DURAVIT SIPHON COVER FIXINGS ALL EXCEPT 863.88/865.18

<p>1</p>  <p>063.81 STARCK 3 STANDARD SEAT</p>	<p>2</p>  <p>063.89 STARCK 3 SOFT CLOSE SEAT</p>	<p>3</p>  <p>067.31 D-CODE STANDARD SEAT- METAL HINGES</p>	<p>4</p>  <p>067.39 D-CODE SOFT CLOSE SEAT</p>
<p>5</p>  <p>063.71 DURASTYLE STANDARD SEAT</p>	<p>6</p>  <p>063.79 DURASTYLE SOFTCLOSE SEAT</p>	<p>7</p>  <p>020.01 ME BY STARCK STANDARD TOILET SEAT FOR 2528.09HG AND 2169.09HG</p>	<p>8</p>  <p>020.09 ME BY STARCK SOFT CLOSE TOILET SEAT FOR 2528.09 & 2169.09 ONLY</p>
<p>9</p>  <p>020.11 ME BY STARCK STANDARD TOILET SEAT FOR 2170.09 & 2530.09</p>	<p>10</p>  <p>020.19 ME BY STARCK STANDARD TOILET SEAT FOR 2170.09 & 2530.09</p>	<p>11</p>  <p>064.20 DURAPLUS TOILET SEAT WHITE WITH METAL HINGES</p>	<p>12</p>  <p>064.29 DURAPLUS SOFT CLOSE SEAT</p>
<p>13</p>  <p>020.49 P3 SOFT CLOSE TOILET SEAT FOR 2167.09 BTW SUITE ONLY</p>	<p>14</p>  <p>020.79 DURASTYLE BASIC SOFT CLOSE SEAT</p>	<p>15</p>  <p>064.59 HAPPY D.2 SOFT CLOSE SEAT</p>	<p>16</p>  <p>063.51 (DISCONTINUED) REPLACED BY 066.91 DARLING BTW TOILET SEAT</p>
<p>17</p>  <p>064.89 1930 SOFTCLOSE TOILET SEAT</p>	<p>18</p>  <p>064.81 1930 STANDARD TOILET SEAT</p>	<p>19</p>  <p>069.89 SOFT CLOSE SEAT FOR STARCK 2 / DARLING NEW / 138.09 TOILETS</p>	<p>20</p>  <p>066.91 STANDARD TOILET SEAT FOR STARCK 2 / HAPPY D / 138.09</p>

<p>1</p>  <p>066.99 SOFT CLOSE SEAT TO SUIT 138.09 AND 170.09 SUITES, LAYERED LID OLD S2 160.09, 162.09</p>	<p>2</p>  <p>067.69 VERO W/C SEAT SOFT CLOSE</p>	<p>3</p>  <p>065.61 CARO STANDARD TOILET SEAT</p>	<p>4</p>
<p>5</p>	<p>6</p>	<p>7</p>	<p>8</p>
<p>9</p>	<p>10</p>	<p>11</p>	
<p>13</p>	<p>14</p>	<p>15</p>	<p>16</p>
<p>17</p>	<p>18</p>	<p>19</p>	<p>20</p>

1



1001770000
BUFFERS FOR D-CODE SEATS
067.31 AND 067.39, 067.69

2



1001940000
BUFFER SET FOR
STARCK 3 063.81 & STARCK 2
& DARLING NEW 063.89

3



1001470000
BUFFER SET FOR
STARCK 1 SEAT 065.88

4



1003960000
BUFFER SET FOR DURASTYLE
063.71 & 063.79

5



1004100000
BUFFER SET FOR
P3, ME BY STARCK & VERO AIR

6

7

8



1001460000
DURAVIT SEAT BUFFER SET
FOR...064.20, 064.29, 066.91,
060.80, 063.51
CONTAINS 4 SEAT AND 2 LID
BUFFER

9



1001420000
1930S BUFFER SET

10

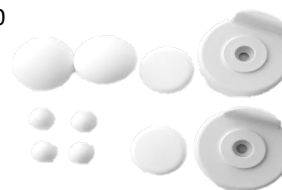

1003720000
BUMPER SET FOR 060.41
D-CODE ELONGATED
ACCESSIBLE SEAT

11

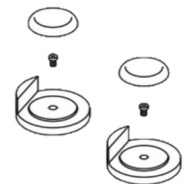





















1004070000
BUMPER SET FOR DURASTYLE
062.31
ELONGATED ACCESSIBLE SEAT



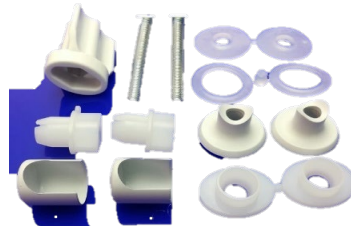



12

13

14

15

<p>1</p>  <p>0061101000 STARCK 1 TOILET SEAT HINGES</p>	<p>2</p>  <p>0063051000 066.91 SEAT HINGES</p>	<p>3</p>  <p>0061121000 STARCK 3 HINGES SET 063.81</p>	<p>4</p>  <p>0061431000 HINGES FOR 069.51, 063.51 SEAT STAINLESS STEEL</p>
<p>5</p>  <p>0064991000 HINGE FOR 064.20/060.80 TOILET SEAT CAN BE ALSO USED ON THE 82A/REGAL</p>	<p>6</p>  <p>0061181000 HINGES FOR TOILET SEAT</p>	<p>7</p>  <p>006109100 HINGES FOR CARO TOILET SEAT CHROME</p>	<p>8</p>  <p>0061391000 HINGES FOR D-CODE SEAT 067.31</p>
<p>9</p>  <p>0061081000 DURAVIT 1930S NEW STYLE HINGE SET</p>	<p>10</p>  <p>0061221000 DURAVIT 1930S OLD STYLE HINGE SET (PRE OCT 2004)</p>	<p>11</p>  <p>0063021000 HAPPY D/STARCK2 MOUNTING BLOCK FOR SEAT HINGE</p>	<p>12</p>  <p>0050501000 PLASTIC RAWLPLUG FOR FIXING TOILET SEATS (SINGLE PLUG) (NYLON INSERT BUSH)</p>
<p>13</p>  <p>006138100 STARCK 3 SOFT CLOSE HINGE SET</p>	<p>14</p>  <p>1004270000 SOFT CLOSE MECHANISM STARCK 3 (063.89 & 069.89)</p>	<p>15</p>  <p>0061410000 HINGE SET FOR D-CODE SOFT CLOSE SEAT 067.39</p>	<p>16</p>  <p>1002560000 SOFT CLOSE MECHANISM FOR D-CODE (PAIR) SOFT CLOSE SEAT 067.39</p>
<p>17</p>  <p>0061761000 DURASTYLE SOFTCLOSE HINGE SET</p>	<p>18</p>  <p>1004250000 SOFT CLOSE MECHANISM DURASTYLE 063.79</p>	<p>19</p>  <p>0061631000 HINGE SET FOR 069.89, 064.59 HAPPY D 2, STARCK 2, DARLING SEAT</p>	<p>20</p>  <p>1004230000 SOFT CLOSE MECHANISM FOR HAPPY D.2 064.59</p>

<p>1</p>  <p>0061981000 DURASTYLE BASIC SEAT FIXING KIT 020.79</p>	<p>2</p>  <p>1004180000 DURASTYLE BASIC SOFT CLOSE HINGES FOR 020.79</p>	<p>3</p>  <p>0020081000 HINGE SET FOR P3 & ME BY STARCK SOFT CLOSE SEAT CODE 020.49, 020.09 & 020.19</p>	<p>4</p>  <p>1004130000 ME BY STARCK SOFT CLOSE MECHANISM FOR 020.19</p>
<p>5</p>  <p>1004140000 ME BY STARCK SOFT CLOSE MECHANISM FOR 020.09</p>	<p>6</p>  <p>1003290000 SOFT CLOSE MECHANISM FOR SET 068.99 FOR 2ND FOOR SEAT</p>	<p>7</p>  <p>0061681000 SOFT CLOSE MECHANISM FOR SET 064.29 FOR DURAPLUS SEAT</p>	<p>8</p>
<p>9</p>	<p>10</p>	<p>11</p>	<p>12</p>
<p>13</p>	<p>14</p>	<p>15</p>	<p>16</p>
<p>17</p>	<p>18</p>	<p>19</p>	<p>20</p>



**Valsir Cisterns Push Panels
For Mechanical Cisterns**

Code	Description	Photo
Egea Single Flush ABS Plastic	823901	White
Medusa Single Flush ABS Plastic	VS0804001 VS0804035 VS0804037	White Chrome Satin
Rios Dual Flush ABS Plastic	VS0828501 VS0828535 VS0828537	White Chrome Satin
Tropea 2 Dual Flush ABS Plastic	Use Replacement panels TROPEA 2 Below	No longer available
245mm x 165mm ABS Plastic	VS0872501 VS0872535 VS0872537	White Chrome Satin
245mm x 165mm Metal	VS0872701 VS0872735 VS0872737	White Chrome Satin

Code	Description	Photo
Tropea 3		
Dual Flush	VS0872512	White
245mm x 165mm	VS0872534	Chrome
ABS Plastic	VS0872536	Satin
		
245mm x 165mm	VS0870834	Chrome
Metal	VS0870836	Satin
		
215mm x 145mm	VS0871301	White
ABS Plastic	VS0871335	Chrome
	VS0871337	Satin
	VS0871303	Matt Black
	VS0871300	Matt White
		
Tropea S		
Dual Flush	VS0871301	White
215mm x 145mm	VS0871335	Chrome
ABS Plastic	VS0871337	Satin
	VS0871303	Matt Black
	VS0871300	Matt White
		
245mm x 165mm	VS0870235	Chrome
Metal	VS0870237	Satin
		
215mm x 145mm	VS0869201	White
ABS Plastic	VS0869235	Chrome
	VS0869237	Satin
		
215mm x 145mm	VS0869301	White
ABS Plastic	VS0869335	Chrome
	VS0869337	Satin
		

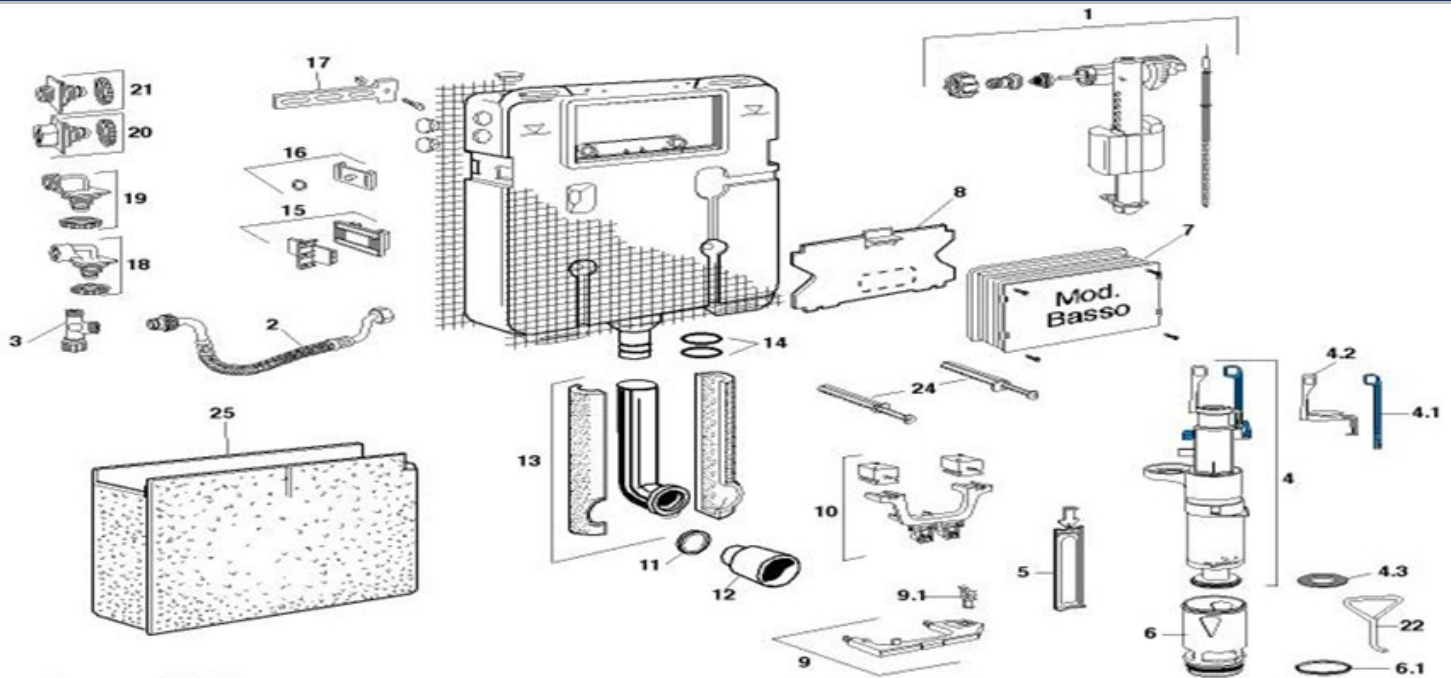

POS.	DESCRIPTION	CODE
1	Inlet valve	VS0868011
2	Hose 3/8" x 3/8"	VS0866118
3	Stop valve male 3/8" x male 3/8"	VS0868310
4	Outlet valve - dual flush - without cradle	VS0866154
4.1	Hook for half flush NOT AVAILBLE PLEASE	VS0863127
4.2	Hook for full flush ORDER COMPLETE VALVE	VS0866121
4.3	Washer	VS0801017
5	Gauge rod - holder for outlet valve	VS0866113
6	Cradle with o-rings (Seat)	VS0866157
6.1	O-ring	VS0820439
7	Protective box - low type	VS0863167
8	Anti condensation plate	VS0863125
9	Mechanisms holding bridge	VS0866112
9.1	Inlet valve clip	VS0820111
10	Levers holder	VS0820376
11	Washer	VS0820119
12	Plug 44mm	VS0802011
13	Flush pipe 380mm	VS0800184
14	O-ring for cistern spigot	VS0800139
15	Fixing kit to Block frames	VS0866166
16	Fixing kit to Fixsistem frames	VS0866165
18	Square flange elbow female G1/2"	VS0868301
22	Hook Tool for cradle removal	VS0805153
24	Spacers	VS0864166
25	Anti condensation lining	VS0866111

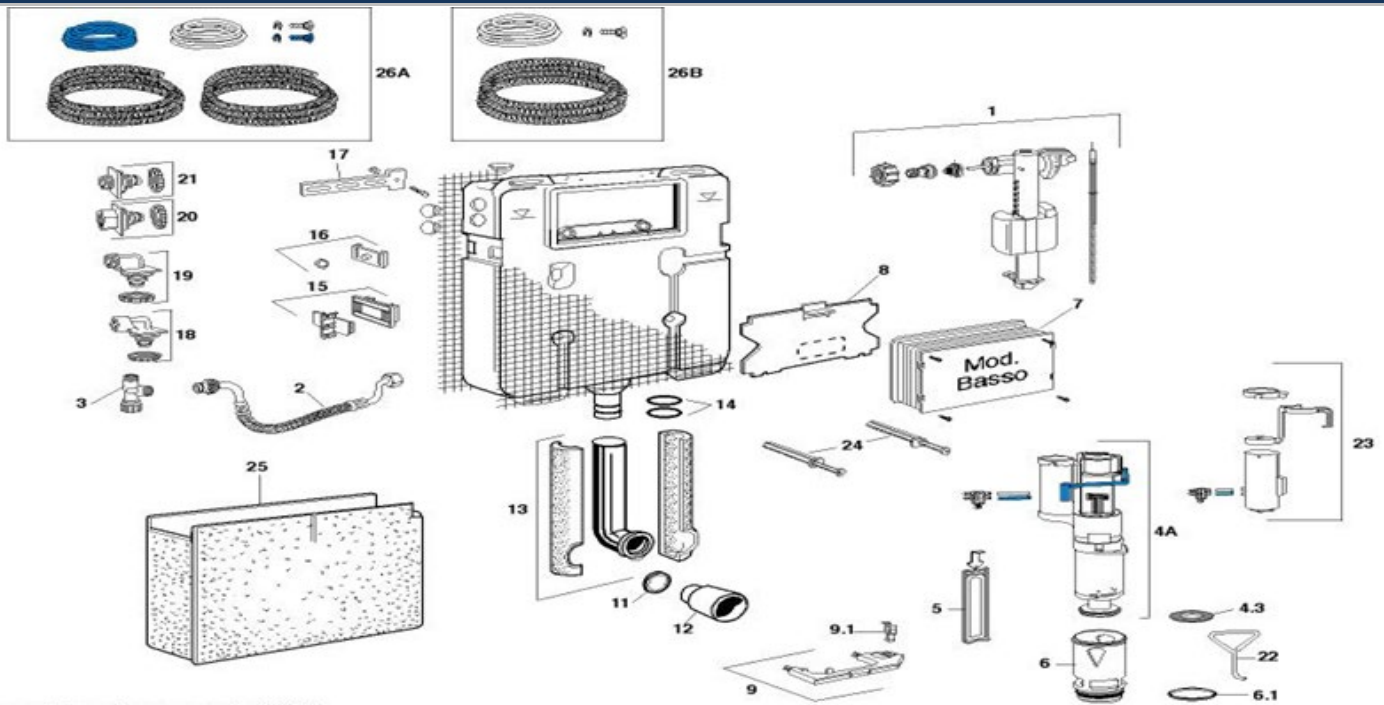

Cassetta incasso Tropea 2 pneu con rete 866003
 Cassetta incasso Tropea 2 pneu con foderina 866903



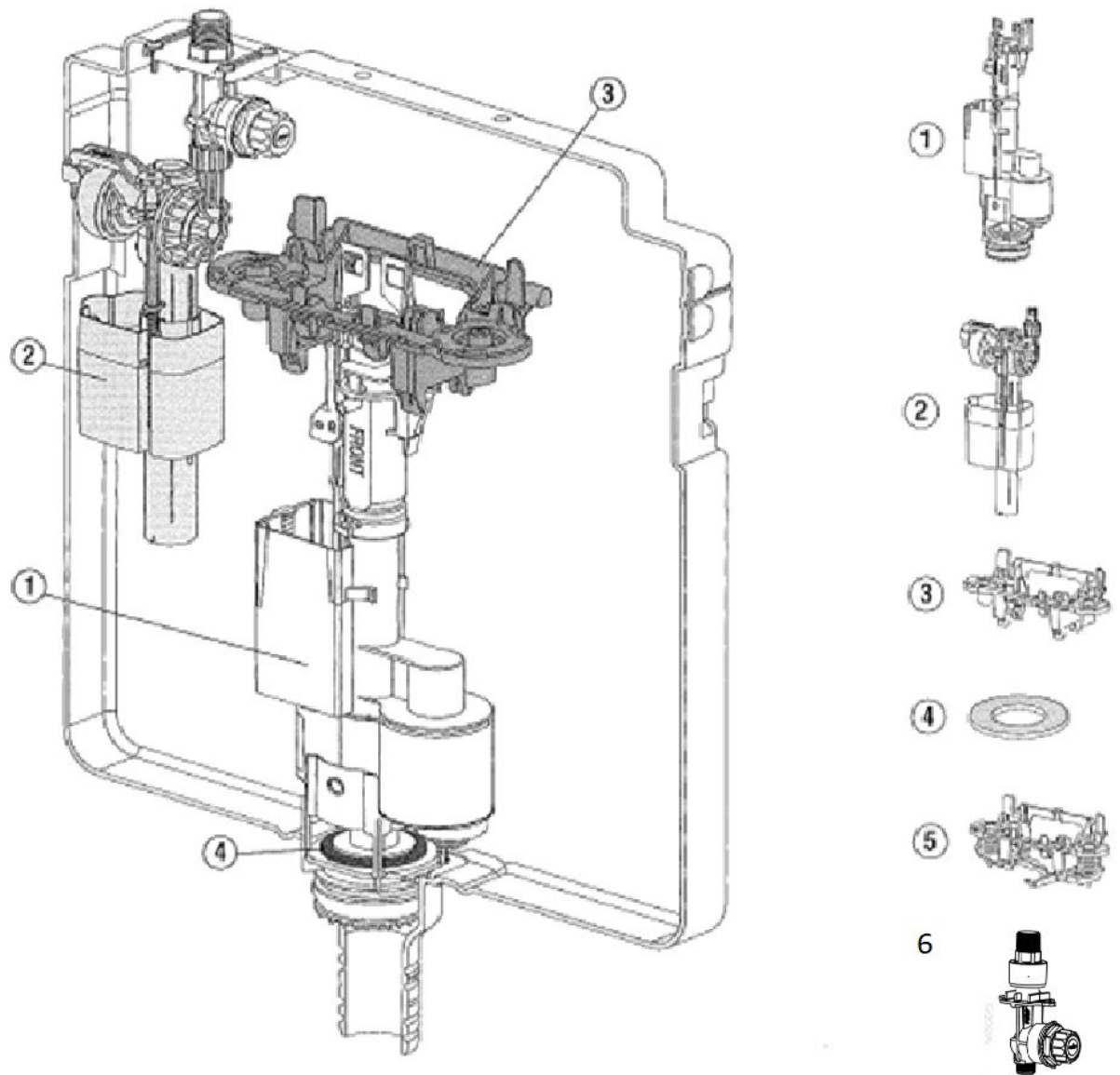





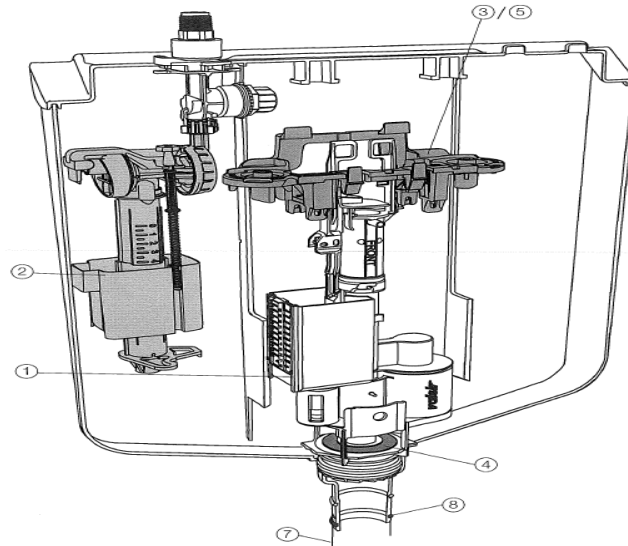

1	Inlet valve "Compact"	VS0868011
2	Hose 3/8" x 3/8"	VS0866118
3	Stop valve male 3/8" x male 3/8"	VS0868310
4A	Pneumatic outlet valve - dual flush - without cradle	VS0866161
4.3	Washer	VS0801017
5	Gauge rod - holder for outlet valve	VS0866113
6	Cradle with o-rings	VS0866157
6.1	O-ring	VS0820439
7	Protective box	VS0863167
8	Anti condensation plate	VS0863125
9	Mechanisms holding bridge	VS0866112
9.1	Inlet valve hook	VS0820111
11	Washer 2Lt	VS0820119
12	Plug 44mm	VS0802011
13	Flush pipe 380mm	VS0800184
14	O-ring for cistern spigot	VS0800139
15	Fixing kit to Block frames	VS0864166
16	Fixing kit to Fixsystem frames	VS0866165
17	Metal fixing brackets with screws	VS0820221
18	Square flange elbow female G1/2"	VS0868301
19	Square flange elbow male G1/2"	VS0868303
20	Square flange straight fitting female G1/2"	VS0868305
21	Square flange straight fitting male G1/2"	VS0868307
22	Hook for cradle pull out	VS0805153
23	Pneumatic device for Tropea2	VS0866160
24	Spacers	VS0864166
25	Anti condensation lining	VS0866111
26A	Pipes kit for pneu. connection dual flush - 2.5mt	VS0872206
26B	Pipes kit for pneu. connection single flush - 2.5mt	VS0872204



N.	COD.
1	VS0866690
2	VS0866693
3	VS0866694
4	VS0866603
5	VS0866692
6	VS0866635

Description
Tropea3 valve
Compact float valve
Central block
Seal for outlet valve
Pneumatic kit
Stop Valve





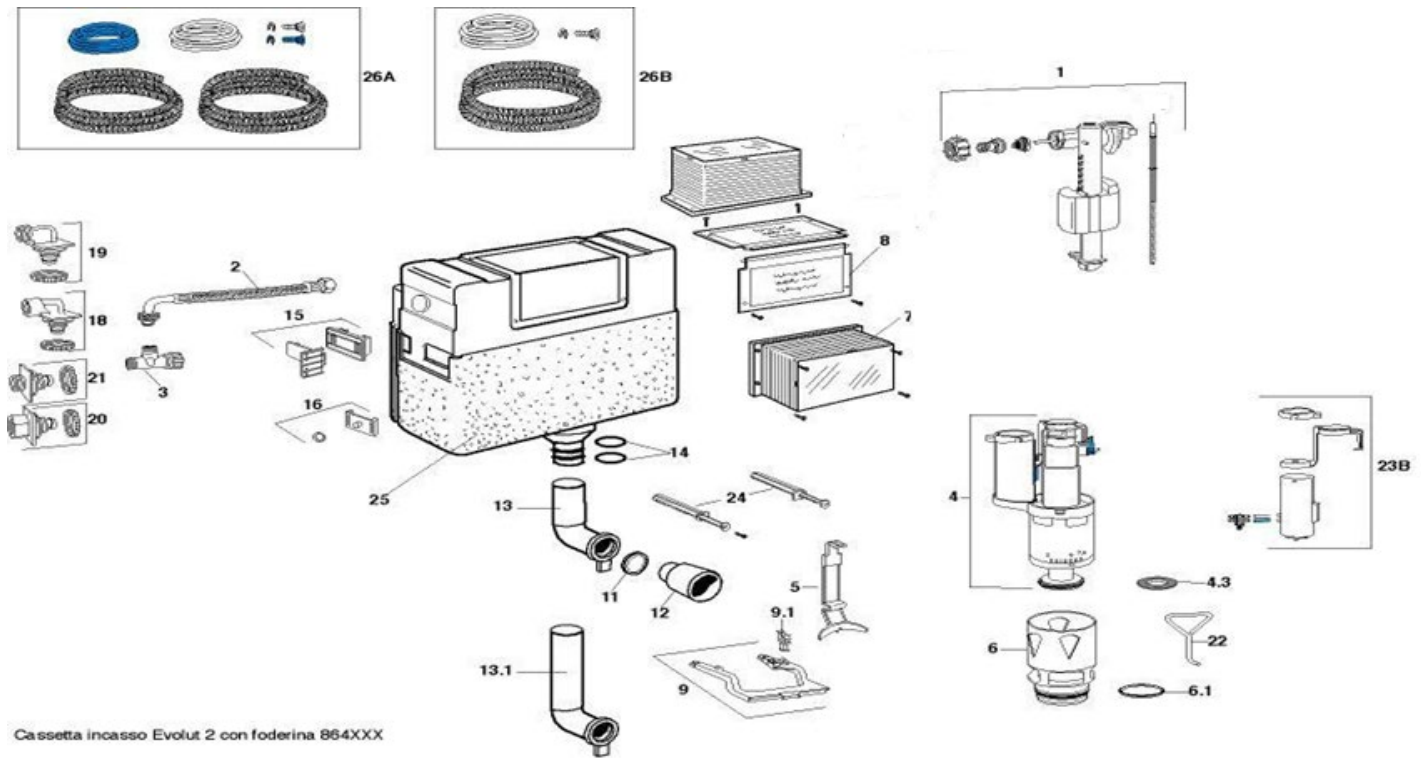





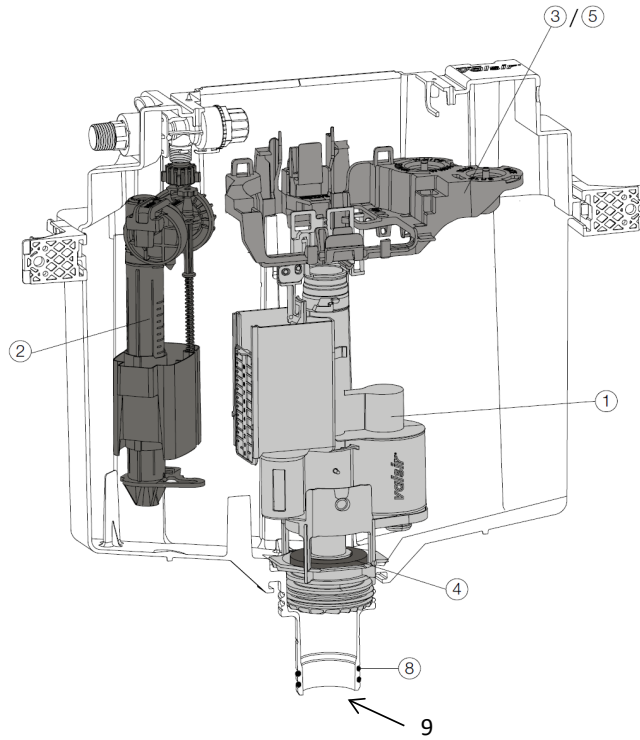

2016			COD.
①		Tropea S/Tropea S mechanical valve	VS0866690
②		Compact float valve	VS0866693
③		Tropea S central block	VS0866794
④		Seal for outlet valve	VS0866603
⑤		Tropea S mechanical to pneumatic conversion kit	VS0866792
⑥		Pneumatic to mechanical conversion kit	VS0866696
⑦		Flush pipe kit for Tropea S/Tropea S	VS0866580
⑧		O-ring for connection pipe (2 pcs)	VS0820163
⑨		2-lip seal for pipe	VS0820119
		Stop Valve	VS0866635
		Protective case	VS0866625



Cassetta in acciaio Evolut 2 con foderina 864XXX

POS.	DESCRIZIONE	DESCRIPTION	CODE
1	Rubinetto galleggiante Compact	Inlet valve "Compact"	VS0868011
2	Tubo flessibile 3/8 x 3/8 Evolut	Hose 3/8"x3/8"	VS0864118
3	Rubinetto d'arresto M3/8" x M3/8"	Stop valve male 3/8" - male 3/8"	VS0868310
4	Valvola Evolut 2 Q.tà senza piletta	Outlet valve without cage	VS0864157
4.3	Guarnizione per valvola di scarico	Washer	VS0801017
5	Asta di bloccaggio Valvola Evolut	Outlet valve locker	VS0864119
6	Kit piletta Evolut con O-ring	Outlet valve cradle with o-ring	VS0863157
6.1	O-ring per piletta	O-ring	VS0820161
7	Cassa di protezione Evolut	Box	VS0864167
8	Placca girevole laserata Evolut	Swivel plate - laser marked	VS0864141
9	Blocco centrale cassetta Evolut	Bridging piece	VS0864117
9.1	Gancio blocca galleggiante	Inlet valve hook	VS0820111
11	Guarnizione 2 Lt.	Washer 2Lt	VS0820119
12	Tappo di protezione diam.44	Plug 44mm	VS0802011
13	Tubo risc.d.56x121 Evolut	Flush pipe 56x121	VS0864155
13.1	Tubo Risciac. D.56X283 Evolut/Space	Flush pipe 56x283	VS0864154
14	O-ring per boocchettone	O-ring for cistern spigot	VS0820163
15	Kit fissaggio block Evolut	Fixing brackets kit for Block frames	VS0863166
16	Kit fissaggio cassetta fixsystem	Fixing brackets kit for Fixsystem frames	VS0866165
18	Raccordo gomito flangiato quadro F G1/2	Square flange elbow female G1/2"	VS0868301
19	Raccordo gomito flangiato quadro M G1/2	Square flange elbow male G1/2"	VS0868303
20	Raccordo diritto flangiato quadro F G1/2	Square flange straight fitting female G1/2"	VS0868305
21	Raccordo diritto flangiato quadro M G1/2	Square flange straight fitting male G1/2"	VS0868307
22	Gancio estrazione piletta	Hook for cradle pull out	VS0805153
23	Meccanismo pneumatico modello Evolut	Pneumatic device	VS0863160
24	Distanziatori di fissaggio	Spacers	VS0864166
25	Foderina anticondensa Evolut	Anti condensation lining	VS0864111
26A	Kit coll.pneus 2 q.tà, mt.2,5	Pipes kit for pneu. connection dual flush - 2.5mt	VS0872206
26B	Kit coll.pneus scarico semplice, mt.2,5	Pipes kit for pneu. connection single flush - 2.5mt	VS0872204



①		Winner S mechanical valve	VS0866790
②		Compact float valve	VS0866693
③		Winner S central block	VS0866994
④		Seal for outlet valve	VS0866603
⑤		Winner S mechanical to pneumatic conversion kit	VS0866992
⑥		Pneumatic to mechanical conversion kit	VS0866796
⑧		O-ring for connection pipe (2 pcs)	VS0820163
⑨		2-lip seal for flush pipe	VS0820119
⑩		Protective case	VS0866625
⑪		Flush pipe kit for Winner S H 800/820/880	VS0863509
⑫		Flush pipe kit for Winner S H 1050/1140	VS0868284

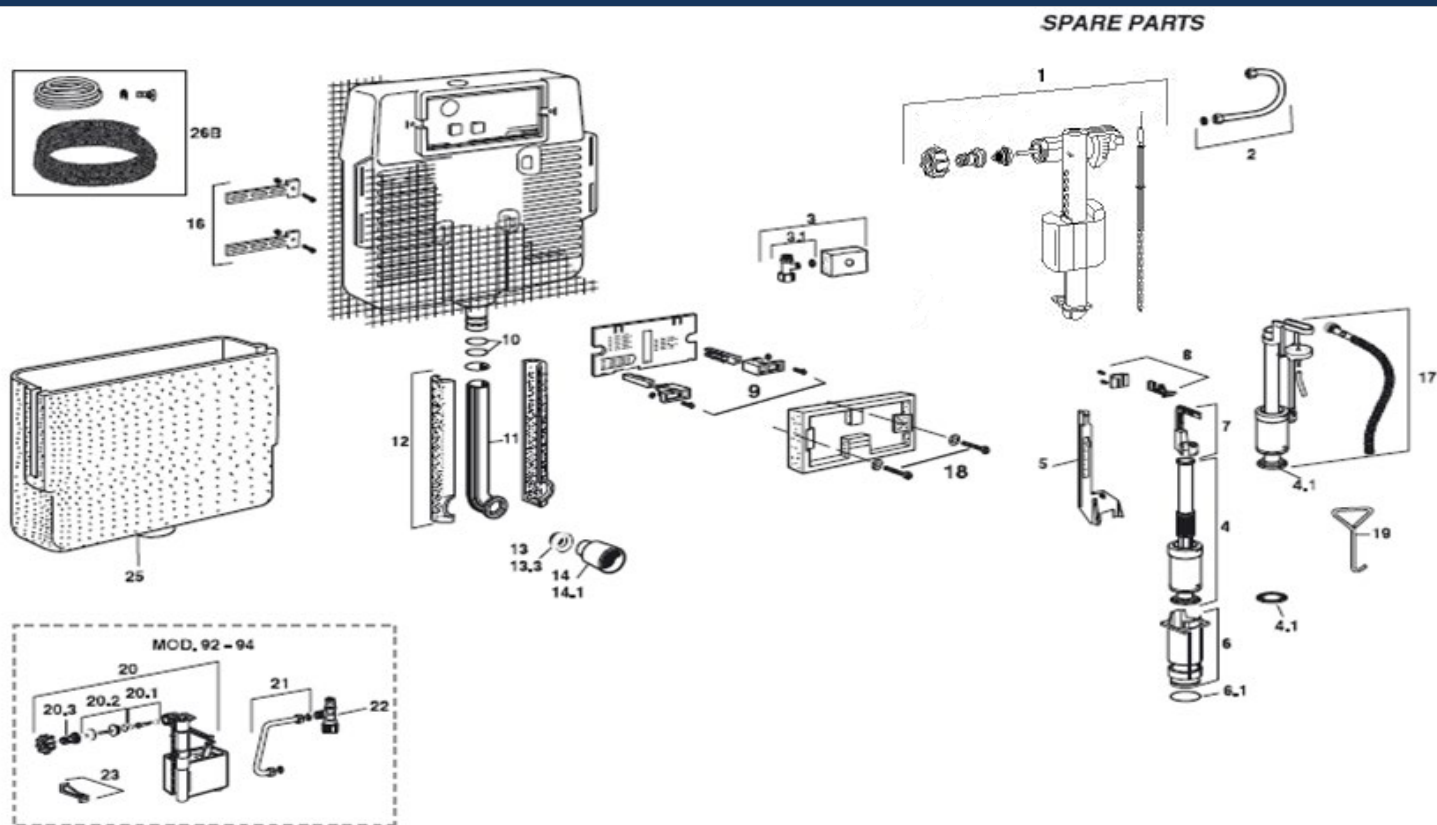

POS.	DESCRIPTION	CODE	POS.	DESCRIPTION	CODE
1	Inlet valve	VS0868011	10	O-ring for flush pipe	801021
2	Copper bend	801032	11	Gflush pipe	802046
3	Stop valve male 1/2" x male 3/8"	820208	12	Polystyrene protection for flush pipe	802057
3.1	Stop valve with ring seal 1/2"x3/8"	820152	13	Rubber adaptor d.32	802004
4	Outlet valve	801011	13.3	Rubber adaptor d.40-44	802016
4.1	Seal for outlet valve	801017	14	Protective plug d.40	802009
5	Gauge rod - holder for outlet valve	801009	14.1	Protective plug d.44	802011
6	Cradle with o-rings	801015	16	Fixing plate with screw	820221
6.1	O-ring	801019	17	Pneumatic outlet valve	804660
7	Kit with lever and anchor	801013	18	Screws 4.2x45	801033
8	Bracket for fixing float valve	801010	19	Hook for guide removal	805153
9	Plate fastener -2 pcs	801025	20	3/8" float valve	801007
			20.1	piston	817091
			20.2	Silencing devise for inlet valve	817093
			20.3	Brass connector 3/8"	817201
			21	Copper bend	801005
			22	1/2" stop valve	801003
			23	Cistern protective element	801052
			25	Anti condensation lining	802051
			26B	Pipe for pneumatic mechanism	872204

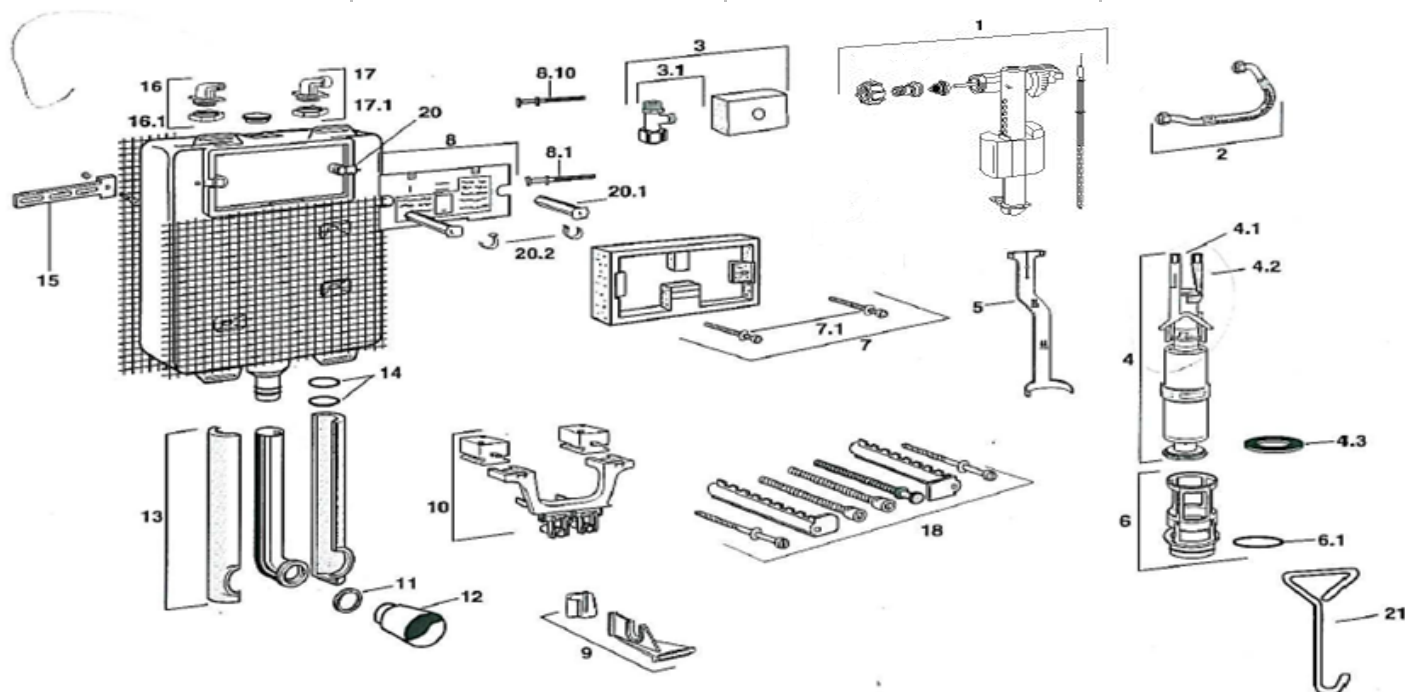

No.	Code	Description			
1	VS0868011	Float valve 3/8"	11	VS0802119	RIOS FLUSHPIPE SEAL
2	820096	Flexible pipe with seal	12	802011	Protective plug D 44
3	820209	Stop valve and protective sponge 1/2" x 3/8"	13	800184	Pipe with seal and polystyrene protective covering H 380
4A	820471	Outlet valve with anchor	15	820221	Fixing plate with screws (2 pcs)
4	820441	Outlet valve with anchors (dual flush)	16	820137	Fitting for water supply connection 1/2"F x 1/2"M
4.1	800178	Anchor and lever for half flush/full flush	16.1	820136	3/8"M fitting for water supply connection 1/2"F x 1/2"M
4.3	801017	Seal for outlet valve	17	820139	Fitting for water supply connection 3/8"F x 3/8"M
5	800245	Gauge and attachment rod for outlet valve	17.1	820140	Fitting for water supply connection 1/2"F x 1/2"F
6	820437	Guide for outlet valve with ring seal	18	866166	Attachment kit
6.1	820439	O-ring for guide 4 x 54.5	19	822907	Pneumatic mechanism
7	800176	Protective plate in polystyrene with screws	20	820373	Short connector for attaching plate (1pc)
8	820481	Anti-condensation plate with screws for control mechanism	20.1	820167	Short spacers for attaching plate (2 pcs)
8.1	820118	Screws for control mechanism for half flush/full flush			
9	820260	Central block for float valve			
9.1	820111	Hook for securing float valve			
10	820376	Bracket for lever (dual flush)			

MOD. 96-2007

5 800123 Gauge and attachment rod for outlet valve

9 820378 Bracket for fixing float valve

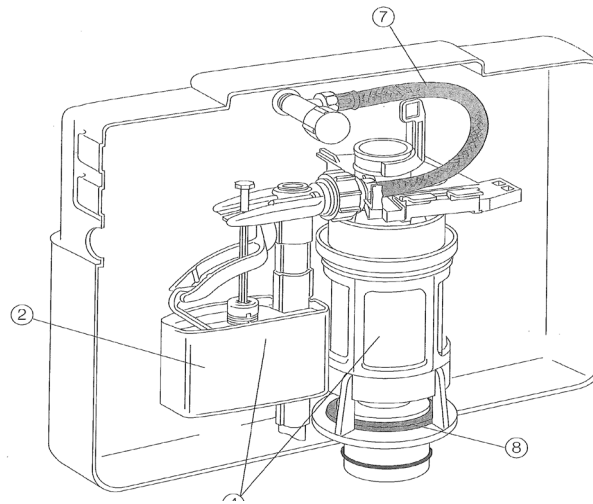

1996-2003

COD.

①		Valve kit from 1996 to 2003	VS0827801
---	---	-----------------------------	-----------

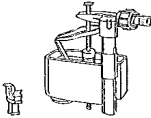
②		Dual flush float valve kit from 1996 to 2010	VS0820804
---	--	--	-----------

③		Lever kit	VS0827808
---	---	-----------	-----------

Set ricambi - Set spare parts (1+2+3)

VS0827811

2003-2010

COD.

















④		Cistern kit from 2003 to 2010	VS0827802
---	---	-------------------------------	-----------









⑤		Mechanical to pneumatic conversion kit from 2003 to 2010	VS0822909
---	---	--	-----------

⑥		Lever kit	VS0827808
---	---	-----------	-----------

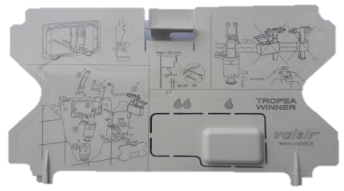
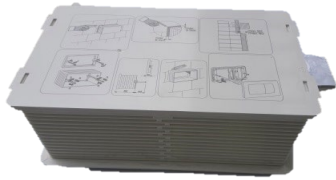









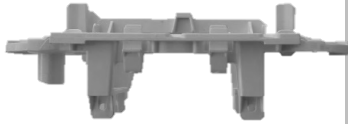

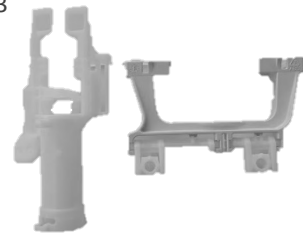
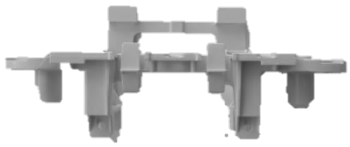
⑦		Flexible hose for models from 2009 to 2010	VS0824111
---	---	--	-----------

⑧		Seal for outlet valve	VS0866603
---	---	-----------------------	-----------









<p>1</p>  <p>VS0801011 MEDUSA OUTLET UNDERWATER VALVE</p>	<p>2</p>  <p>VS0804660 MEDUSA PNEUMATIC OUTLET VALVE</p>	<p>3</p>  <p>VS0820472 MEDUSA OUTLET VALVE (NEW)</p>	<p>4</p>  <p>VS0820441 RIOS OUTLET VALVE WITH ANCHORS</p>
<p>5</p>  <p>VS0866154 TROPEA 2 OUTLET VALVE</p>	<p>6</p>  <p>VS0866690 TROPEA S / 3 OUTLET VALVE 6/3 LITRE FLUSH</p>	<p>7</p>  <p>820479 EGEA OUTLET VALVE</p>	<p>8</p>  <p>VS0864157 EVOLUT OUTLET VALVE SAME AS 864159C</p>
<p>9</p>  <p>NO LONGER AVAILABLE USE VS0868011</p> <p>VS0801008 MEDUSA INLET VALVE</p>	<p>10</p>  <p>NO LONGER AVAILABLE USE VS0868011</p> <p>VS0820236 EVOLUT INLET VALVE</p>	<p>11</p>  <p>VS0868011 TROPEA 2 / EVOLUT / MEDUSA / RIOS INLET VALVE</p>	<p>12</p>  <p>VS0866693 TROPEA S / 3 INLET VALVE</p>
<p>13</p>  <p>NO LONGER AVAILABLE USE VS0868011</p> <p>VS0800218 RIOS MONO INLET VALVE REPLACES VS0810183</p>	<p>14</p>  <p>VS0801017 OUTLET VALVE WASHER / MEDUSA / RIOS / EGEA / TROPEA 2</p>	<p>15</p>  <p>VS0866603 TROPEA S / 3 OUTLET VALVE WASHER COLOUR RED</p>	<p>16</p>
<p>17</p>  <p>VS0820111 CLIP FOR TROPEA / EGEA</p>	<p>18</p>  <p>VS0864166 SPACERS FOR TROPEA / EVOLUT (ATTACHES PUSH PANEL TO CISTERN)</p>	<p>19</p>	<p>20</p>

<p>1</p>  <p>863166 TROPEA / EVOLUTE FIXING BRACKET</p>	<p>2</p>  <p>866118 TROPEA FLEXY HOSE</p>	<p>3</p>  <p>802073 TROPEA /EVOLUT FACEPLATE SCREWS (2PCS)</p>	<p>4</p>  <p>VS0822127 SPRING FOR TROPEA 2 FACE</p>
<p>5</p>  <p>VS0863125 TROPEA ANTI-CONDENSATION PLATE</p>	<p>6</p>  <p>VS0863167 TROPEA PROTECTIVE BOX</p>	<p>7</p>  <p>VS0828256S FLUSH PIPE FOR TROPEA 2 40MM</p>	<p>8</p>  <p>VS0866157 TROPEA 2 SEATING NEW</p>
<p>9</p>  <p>VS0805153 HOOK TOOL</p>	<p>10</p>  <p>VS0864167 EVOLUT BOX</p>	<p>11</p>  <p>866116 TROPEA BRIDGE (08)</p>	<p>12</p>  <p>VS0866112 TROPEA BRIDGE OPEN VERSION PRE 2008</p>
<p>13</p>  <p>NO LONGER AVAILABLE USE VS0866163</p> <p>VS0868209C BELLOWS FOR EVOLUT / TROPEA 2 (SAME AS CODE VS0868209)</p>	<p>14</p>  <p>VS0866163 PNEUMATIC BELLOWS KIT FOR TROPEA 2 & EVOLUT REPLACES VS0868209C</p>	<p>15</p>  <p>VS0866113 TROPEA GAUGE ROD</p>	<p>16</p>  <p>870213 LEVER FOR TOTAL FLUSH WITH SPRING</p>
<p>17</p>  <p>864118 EVOLUT INLET HOSE</p>	<p>18</p>  <p>864119 EVOLUT GAUGE ROD</p>	<p>19</p>  <p>826065 EVOLUTE PIPE CLIP</p>	<p>20</p>  <p>VS0864117 EVOLUT BRIDGE</p>



<p>1</p>  <p>VS0868130 TROPEA & EVOLUT STOP VALVE</p>	<p>2</p>  <p>868303 CAST INLET ELBOW NZ VERSION MALE</p>	<p>3</p>	<p>4</p>
<p>5</p>	<p>6</p>	<p>7</p>	<p>8</p>
<p>9</p>	<p>10</p>	<p>11</p>	<p>12</p>
<p>13</p>	<p>14</p>	<p>15</p>	<p>16</p>
<p>17</p>	<p>18</p>	<p>19</p>	<p>20</p>

<p>1</p>  <p>VS0866694 TROPEA 3 BRIDGE</p>	<p>2</p>  <p>VS0866692 TROPEA 3 PNEUMATIC KIT</p>	<p>3</p>  <p>VS0866696 TROPEA S PNEUMATIC TO MECHANICAL KIT (ALSO FOR FOR T3)</p>	<p>4</p>  <p>VS0866794 TROPEA S CENTRAL BLOCK</p>
<p>5</p>  <p>VS0866792 TROPEA S MECHANICAL TO PNEUMATIC</p>	<p>6</p>  <p>VS0868278 SUPPORT FOR WC BEND FOR TROPEA S AND WINNER S</p>	<p>7</p>  <p>VS0863509 WINNER S FLUSH PIPE KIT FOR 880H CISTERN ONLY VS0853058</p>	<p>8</p>  <p>VS0866580 TROPEA S / 3 FLUSH PIPE 50MM (FROM THE CISTERN FITS)</p>
<p>9</p>  <p>VS0866695 TROPEA 3 FLUSHING SCREWS BLUE AND WHITE RODS SOLD AS PAIR</p>	<p>10</p>  <p>VS0866796 WINNER S KIT FROM PNEUMATIC TO MECHANICAL</p>	<p>11</p>  <p>VS0866992 WINNER S KIT FROM MECHANICAL TO PNEUMATIC</p>	<p>12</p>  <p>VS0868284 WINNER S FLUSH PIPE H = 1050MM AND 1140MM FOR VS0853052</p>
<p>13</p>  <p>VS0866625 TROPEA S, WINNER S PROTECTIVE BOX</p>	<p>14</p>	<p>15</p>	<p>16</p>
<p>17</p>	<p>18</p>	<p>19</p>	<p>20</p>

<p>1</p>  <p>VS0801013 MEDUSA LEVER FOR OUTLET VALVE ANCHOR</p>	<p>2</p>  <p>VS0801010 MEDUSA BRIDGE FOR INLET VALVE</p>	<p>3</p>  <p>VS0800245 NEW MEDUSA/RIOS OUTLET GAUGE ONLY FOR 2010 ONWARDS</p>	<p>4</p>  <p>VS0804050 MEDUSA PUSH PLATE LEVER</p>
<p>5</p>  <p>VS0801218 MEDUSA LEVER AND ANCHOR</p>	<p>6</p>  <p>VS0817104 NUT FOR MEDUSA / RIOS INLET VALVE</p>	<p>7</p>  <p>VS0801009 MEDUSA GAUGE ROD FOR CISTERN</p>	<p>8</p>  <p>VS0802016 MEDUSA FLUSH PIPE SEAL REPLACES VS0802007 (AT THE CURVED END OUTLET)</p>
<p>9</p>  <p>820157 STOP VALVE EGEEA / RIOS INLET VALVE</p>	<p>13</p>  <p>839096 VANDAL PROOF SCREWS RIOS S/S PLATE</p>	<p>11</p>  <p>839097 HEX KEY FOR VANDAL PROOF SCREWS</p>	<p>12</p>
<p>13</p>	<p>14</p>	<p>15</p>	<p>16</p>
<p>17</p>  <p>VS0823174 EGEEA CENTRAL BLOCK</p>	<p>18</p>  <p>823021 MOVEMENT LEVER FOR EGEEA PUSH PANEL</p>	<p>19</p>  <p>823020 SCREW FOR EGEEA CONTROL MECHANISM</p>	<p>20</p>  <p>VS0823685 LEVER FOR EGEEA PUSH PANEL</p>

<p>1</p>  <p>VS0875425 NEW CODE SINGLE PNEUMAT BUTTON NO PLATE CP FULL FLUSH</p>	<p>2</p>  <p>VS0875426 NEW CODE SINGLE PNEUMAT BUTTON NO PLATE CP HALF FLUSH</p>	<p>3</p>  <p>VS0873335 TROPEA S / EVOULT REMOTE ROUND DUAL PUSH BUTTONS ABS CHROME FINISH 46MM DIAMETER BUTTONS</p>	<p>4</p>  <p>VS0873337 TROPEA S / EVOULT REMOTE ROUND DUAL PUSH BUTTONS ABS SATIN FINISH 46MM DIAMETER BUTTONS</p>
<p>5</p>  <p>VS0872206 PNEUM. TUBING KIT 2.5M</p>	<p>6</p>  <p>VS0804697 VALSIR WHITE PNEUM TUBE 360MM VS0804698 VALSIR BLUE PNEUM TUBE</p>	<p>7</p>  <p>VS0868930 VALSIR POWER SUPPLY FOR INFRA RED FLUSH PANEL VSO868901</p>	<p>8</p>  <p>802301 MEDUSA SINGLE FLUSH PNEUMATIC BUTTON WHITE ONLY AVAILABLE 105MM DIA</p>
<p>9</p>	<p>10</p>	<p>11</p>	<p>12</p>
<p>13</p>	<p>14</p>	<p>15</p>	<p>16</p>
<p>17</p>	<p>18</p>	<p>19</p>	<p>20</p>

<p>1</p>  <p>820367 TROPEA / RIOS SCREW FOR HALF FLUSH</p>	<p>2</p>  <p>820096 FLEXIBLE SUPPLY HOSE RIOS CISTERN</p>	<p>3</p>  <p>VS0820437 SEAT FOR OUTLET VALVE RIOS/MEDUSA FOR LATE MODEL MEDUSA/ RIOS FROM</p>	<p>4</p>  <p>VS0816005 FLUSH PIPE BUSH 44MM FOR ALL RIOS/MEDUSA/TROPEA/EGEA (KEE SEAL)</p>
<p>5</p>  <p>VS0802119 FLUSH PIPE SEAL FOR TROPEA S, TROPEA 3, EVOLUT, RIOS (FITS INSIDE FLUSH PIPE FROM CISTERN AT PAN END)</p>	<p>6</p>  <p>801006 * DISCONTINUED * INLET VALVE FIBRE WASHER *DISCONTINUED FROM</p>	<p>7</p>  <p>VS0802016 MEDUSA KEY SEAL FOR FLUSHPIPE</p>	<p>8</p>  <p>VS08766641 ARIAPUR MODIFIED FLUSH PIPE DIA.56MM FOR TROPEA S</p>
<p>9</p>  <p>VS0874022 ARIAPUR MODIFIED FLUSH PIPE DIA.56MM</p>	<p>10</p>  <p>VS0531325 ARIAPUR PVC ADAPTOR</p>	<p>11</p>  <p>VS0803901 FLUSH PIPE CONNECTION 500MM LONG, 40MM DIA. FOR TROPEA S / WINNER S INCLUDES 44MM BUSH ***NEEDS VS0828201 45/40 ADAPTOR***</p>	<p>12</p>  <p>VS0803101 VALSIR CONNECTION PIPE WITH INTERNAL REDUCTION 40/32MM, 250MM LENGTH WITH GROMMET</p>
<p>13</p>  <p>VS0534001 110MM 90 DEGREE BEND</p>	<p>14</p>  <p>VS0536005 110MM ECCENTRIC PAN CONNECTOR</p>	<p>15</p>  <p>VS0364008 ELBOW FOR 866319 (90MM,90 DEGREE)</p>	<p>16</p>  <p>VS0587001 REDUCER RUBBER GASKET 90/100 VALSIR SLEEVE FOR</p>
<p>17</p>  <p>VS0366001 866319 STRAIGHT PAN CONNECTOR INCLUDES 44MM DIA. FLUSH PIPE CONNECTOR &</p>	<p>18</p>  <p>583001 PAN CONNECTOR SEAL (FOR 866319)</p>	<p>19</p>  <p>VS0366133 LONG STRAIGHT PAN CONNECTOR FOR TROPEA FULL FRAME CISTERN, 300MM L</p>	<p>20</p>  <p>VS0866580 TROPEA S / 3 FLUSH PIPE (FROM THE CISTERN /FITS MEDUSA)</p>

<p>1</p>  <p>VS0803202 FLUSH PIPE-PAN CONNECTOR WITH RUBBER BUSH (FULL FRAME VS0803101) BLACK PIPE AND BUSH</p>	<p>2</p>  <p>VS0805350 SILENCER PAD FOR WALL PANS</p>	<p>3</p>  <p>VS0801089 VALSIR INLET LEVER ARM</p>	<p>4</p>
<p>5</p>	<p>6</p>	<p>7</p>	<p>8</p>
<p>9</p>	<p>10</p>	<p>11</p>	<p>12</p>
<p>13</p>	<p>14</p>	<p>15</p>	<p>16</p>
<p>17</p>	<p>18</p>	<p>19</p>	<p>20</p>

		100-105	135R	205SM	205LL
		SURFACE MOUNTED	BATH SPOUT	SMALL BASIN MIXER	TALL BASIN MIXER
ATACAMA	WWCR***	53CC956GM			
ATOMIX	67CR***	53CC956G40DR2			
AQUA MINIMAL	69CR***	53CC956GMD			
AQUASANIT	42CR***	53CC956G40DAP			
COX	78CR***	53CC956GMD	53CC956G47		53CC956GM
COX SMALL	78CR***			53CC956G25	
COX STAINLESS	78SS***				
DAX	84CR***				
DAX R	84CR***	53CC956GM			53CC956GM
DAX R SMALL	84CR***			53CC956G250	
GHIBLI	44CR***	53CC956GM			
LADY	89CR***	53CC956GM			53CC956G250
LADY SMALL	89CR***			53CC956G250	
LE MANS	90CR***	53CC956GM			
NOVE	09CR***			53CC956D300	53CC956D300
OVO	86CR***	53CC956GMD			53CC956GM
PARALLEL	47CR***	53CC956GMD			
SMART MEDICAL	SHCR***	53CC956GMD			
VENTUS	93CR***	53CC956G40DAP			



		205-201	208-208P	250-251	306
		BASIN MIXER	WALL BASIN MIXER	SWIVEL BASIN MIXER	BIDET MIXER
ATACAMA	WWCR***	53CC956G250	53CC956GM		53CC956G250
ATOMIX	67CR***	53CC956G40DR2			53CC956G40DR2
AQUA MINIMAL	69CR***	53CC956GMD			53CC956GMD
AQUASANIT	42CR***	53CC956G40DAP			53CC956G40DAP
COX	78CR***	53CC956GMD	53CC956GM	53CC956GM	53CC956GMD
COX SMALL	78CR***				53CC956G25
COX STAINLESS	78SS***				
DAX	84CR***		53CC956GM	53CC956GM	
DAX R	84CR***	53CC956G25	53CC956GM	53CC956GM	53CC956G25
DAX R SMALL	84CR***				53CC956G250
GHIBLI	44CR***	53CC956G350	53CC956GM		53CC956G350
LADY	89CR***	53CC956G250	53CC956GM		53CC956G250
LADY SMALL	89CR***	53CC956G250			
LE MANS	90CR***	53CC956G350	53CC956GM	53CC956GM	53CC956G350
NOVE	09CR***	53CC956D300			53CC956D300
OVO	86CR***	53CC956GMD	53CC956GM	53CC956GMD	53CC956GMD
PARALLEL	47CR***	53CC956G350	53CC956GM	53CC956GM	53CC956G350
SMART MEDICAL	SHCR***	53CC956GMD			
VENTUS	93CR***	53CC956G350			53CC956G350













		501	555-557	566	568
		WALL MOUNTED MIXER	KITCHEN MIXER	PULL OUT HOSE KITCHEN	PULLOUT KITCHEN MIXER
ATACAMA	WWCR***	53CC956GM			
ATOMIX	67CR***	53CC956G40DR2			53CC956G40DR2
AQUA MINIMAL	69CR***	53CC956GMD			53CC956GM
AQUASANIT	42CR***	53CC956G40DAP			53CC956G40DAP
COX	78CR***	53CC956GMD	53CC956GM		53CC956GM
COX SMALL	78CR***				
COX STAINLESS	78SS***			53CC956GM	
DAX	84CR***		53CC956GM		
DAX R	84CR***		53CC956GM		
DAX R SMALL	84CR***				
GHIBLI	44CR***	53CC956GM			
LADY	89CR***				
LADY SMALL	89CR***				
LE MANS	90CR***		53CC956GM		
NOVE	09CR***			53CC956GM	
OVO	86CR***		53CC956GMD		
PARALLEL	47CR***		53CC956GM		53CC956GM
SMART MEDICAL	SHCR***	53CC956GMD			53CC956GM
VENTUS	93CR***				53CC956G40DAP



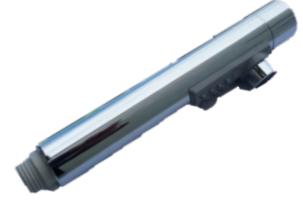



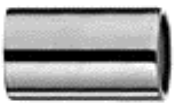
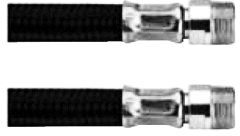











		570-571	572-572SQ	573	579
		KITCHEN MIXER	GOOSENECK KITCHEN	KITCHEN MIXER	KITCHEN MIXER
ATACAMA	WWCR***	53CC956GM		53CC956GM	
ATOMIX	67CR***	53CC956G40DR2	53CC956G40DR2	53CC956G40DR2	
AQUA MINIMAL	69CR***			53CC956GM	
AQUASANIT	42CR***	53CC956G40DAP	53CC956G40DAP	53CC956G40DAP	
COX	78CR***		53CC956GM	53CC956GM	53CC956GM
COX SMALL	78CR***		53CC956G25		53CC956G25
COX STAINLESS	78SS***	53CC956GM		53CC956GM	
		53CC956G25			
DAX	84CR***		53CC956GM		
DAX R	84CR***		53CC956GM		53CC956G250
DAX R SMALL	84CR***				53CC956G25
GHIBLI	44CR***		53CC956GM		
LADY	89CR***				53CC956G250
LADY SMALL	89CR***				
LE MANS	90CR***		53CC956GM	53CC956G350	
NOVE	09CR***	53CC956GM	53CC956GM	53CC956GM	
OVO	86CR***		53CC956GMD		53CC956GM
PARALLEL	47CR***		53CC956GM	53CC956GM	
SMART MEDICAL	SHCR***	53CC956GM		53CC956GM	
VENTUS	93CR***			53CC956G40DAP	









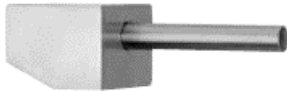





		591	591LL	690-690SM	691-691SM
		PULL OUT HOSE KITCHEN	PULL OUT KITCHEN	SHOWER MIXER	DIVERTOR MIXER
ATACAMA	WWCR***			53CC956GM	53CC956GM
ATOMIX	67CR***			53CC956G40DR2	53CC956G40DR2
AQUA MINIMAL	69CR***			53CC956GM	53CC956GM
AQUASANIT	42CR***			53CC956G40DAP	53CC956G40DAP
COX	78CR***	53CC956GM	53CC956GM	53CC956GM	53CC956GM
COX SMALL	78CR***	53CC956G25		53CC956G25	
COX STAINLESS	78SS***				
DAX	84CR***			53CC956GM	53CC956GM
DAX R	84CR***			53CC956GM	53CC956GM
DAX R SMALL	84CR***			53CC956GM	
GHIBLI	44CR***			53CC956GM	53CC956GM
LADY	89CR***			53CC956GM	53CC956GM
LADY SMALL	89CR***			53CC956GM	
LE MANS	90CR***	53CC956GM	53CC956GM	53CC956GM	53CC956GM
NOVE	09CR***			53CC956GM	53CC956GM
OVO	86CR***	53CC956GM		53CC956GM	53CC956GM
PARALLEL	47CR***	53CC956GM	53CC956GM	53CC956GM	53CC956GM
SMART MEDICAL	SHCR***			53CC956GM	53CC956GM
VENTUS	93CR***			53CC956GM	53CC956GM

<p>1</p>  <p>2TCC959 CARTRIDGE FOR 2TCR690 THERMOSTATIC MIXER</p>	<p>2</p>  <p>53CC956G350 LE MANS AND VENTUS STANDARD BASIN CARTRIDGE</p>	<p>3</p>  <p>53CC956G350EP LE MANS GHIBLI WATER SAVING CARTRIDGE FOR 205 BASIN</p>	<p>4</p>  <p>53CC956G35EP PAINI WATER SAVING CARTRIDGE FOR KITCHEN MIXER 90CR573</p>
<p>5</p>  <p>53CC956G40AP CARTRIDGE FOR VENTUS KITCHENMIXER 568 AND 208</p>	<p>6</p>  <p>53CC956GM AQUA/PAINI CARTRIDGE FOR MOST KITCHEN/SHOWER MIXERS AND 86CR579/78SS566/78SS570</p>	<p>7</p>  <p>VSAC1007/1FOR AQUASANIT 42CR573/42CR205009 42CR568/42CR306/42CR573</p>	<p>8</p>  <p>VSAC1003 CARTRIDGE FOR VSA1003/100 AND FOR 42CR211/205</p>
<p>9</p>  <p>53CC956G250 84CR205RSM SMALL CARTRIDGE AND FOR 84CR579R</p>	<p>10</p>  <p>53CC956GMD AQUA/COX CARTRIDGE FOR MOST BASIN/BIDETS MIXERS</p>	<p>11</p>  <p>53CC581A CUCINA / COX / COLD HEADWORKS</p>	<p>12</p>  <p>53CC581B CUCINA / COX / HOT HEADWORKS</p>
<p>13</p>  <p>53CC956G25 78CR205SM SMALL COX CARTRIDGE AND NEW 84CR205R/78SS572 & 78CR579T90</p>	<p>14</p>  <p>53CC956G35EVA PAINI OFFSET CARTRIDGE 45 DEGREES 572, 572SQ, 591, 591LL, 566, 570 KITCHEN MIXERS</p>	<p>15</p>  <p>53CC956G40DAP AQUASANIT STD CARTRIDGE</p>	<p>16</p>  <p>53CC956G47 PAINI CARTRIDGE FOR 78CR136R</p>
<p>17</p>  <p>53CC956D300 NOVE CARTRIDGE FOR BASIN MIXER 205SM, 205, 205LL</p>	<p>18</p>  <p>53CR581GAD HEADWORK FOR FILTERED WATER HANDLE</p>	<p>19</p>  <p>73CC956 84CR205R BASIN CARTRIDGE FOR OLDER 84CR205R</p>	<p>20</p>  <p>79CC180ZD TUBOS HEADWORKS HOT & COLD</p>



















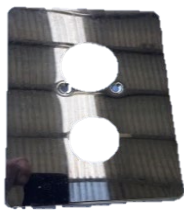

<p>1</p>  <p>81CC956 PIXEL/CRUX REPLACEMENT KIT ==MUST BE SENT OUT WITH == ==== INSTRUCTIONS =====</p>	<p>2</p>  <p>20CC956Q ATOMIX INSIDE CARTRIDGE SQUARE TYPE</p>	<p>3</p>  <p>78CC956P BRASS BUSH FOR CARTRIDGE STEM</p>	<p>4</p>
<p>5</p>	<p>6</p>	<p>7</p>	<p>8</p>
<p>9</p>	<p>10</p>	<p>11</p>	<p>12</p>
<p>13</p>	<p>14</p>	<p>15</p>	<p>16</p>
<p>17</p>	<p>18</p>	<p>19</p>	<p>20</p>

<p>1</p>  <p>53CR155/557 PAINI DUAL MODE KITCHEN SPRAY FOR 78CR556-2 AND 78CR557</p>	<p>2</p>  <p>53CR155/557NSF PAINI HAND SPRAY</p>	<p>3</p>  <p>53CR155591DNSF HAND SPRAY ONLY FOR 591L</p>	<p>4</p>  <p>53CQ155591DNFF2 HAND SPRAY ONLY FOR 591LL, ANTIQUE NICKEL</p>
<p>5</p>  <p>78CR586S HAND SHOWER FOR 78CR568</p>	<p>6</p>  <p>78CR155/556 PAINI SINGLE MODE KITCHEN SPRAY HANDPIECE</p>	<p>7</p>  <p>84CR155 DAX HAND SHOWER HEAD ONLY</p>	<p>8</p>  <p>78CR586ICE HAND PIECE ONLY FOR LE MANS 90CR568 MIXER</p>
<p>9</p>  <p>53CR586IN REPLACEMENT HAND PIECE FOR 42CR568 DUAL SPRAY</p>	<p>10</p>  <p>53CR586VY REPLACEMENT HAND PIECE FOR 47CR568 DUAL SPRAY</p>	<p>11</p>  <p>PAINI HAND SPRAY FOR 591LS A9CR155/5772LF CHROME A9CQ155/5772LF BRUSHED NICKEL A9BK155/5772LF MATT BLACK A9BB155/5772LF BRUSHED BRASS A9GM155/5772LF GUN METAL</p>	<p>12</p>  <p>SS12A HANDPIECE FOR 78SS568</p>
<p>13</p>  <p>78CR591682BC 78CR591 COMPLETE NOZZLE ONLY</p>	<p>1</p>  <p>53CR587/591F HOSE FOR ART. 591 AND 572 3/8" BY 3/8" MALE THREADS- METAL(ALSO USE WASHER CODE GU14X8 FOR EITHER END)</p>	<p>15</p>  <p>53CC586VA PAINI NON RETURN VALVE FOR SHOWER</p>	<p>16</p>  <p>53CR587/FI PULL OUT KITCHEN HOSE FOR PAINI- 591LL MODELS 42CR568 3/8 AND 1/2 FEMALE- METAL</p>
<p>17</p>	<p>18</p>	<p>19</p>	<p>20</p>





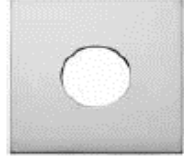





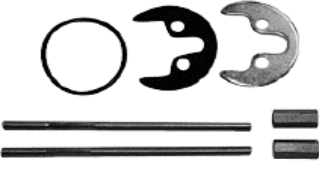







<p>1</p>  <p>78CR910 COX COMPLETE HANDLE</p>	<p>2</p>  <p>78CR910L COX COMPLETE HANDLE W/LONG LEVER</p>	<p>3</p>  <p>78CR911P COX SMALL HANDLE</p>	<p>4</p>  <p>78CR910T9 COX HANDLE ONLY FOR 78CR400</p>
<p>5</p>  <p>78CQ910 COX HANDLE BRUSHED NICKEL</p>	<p>6</p>  <p>78CQ910L COX HANDLE LONG LEVER BRUSHED NICKEL</p>	<p>7</p>  <p>C+78PW910L2HC COX + COMPLETE HANDLE, ANTIQUE NICKEL</p>	<p>8</p>  <p>78CQ910LHC COX HANDLE FOR 78PW205LL WITH HOT AND COLD</p>
<p>9</p>  <p>78BL910 PAINI COX HANDLE - BLACK & CHROME</p>	<p>10</p>  <p>78BL910L PAINI COX HANDLE LONG LEVER,</p>	<p>11</p>  <p>78BK910 PAINI COX HANDLE</p>	<p>12</p>  <p>78BK910L PAINI COX HANDLE LONG LEVER BLACK</p>
<p>13</p>  <p>78GM910 COX HANDLE GUN METAL</p>	<p>14</p>  <p>78BB910 COX HANDLE BRUSHED BRASS</p>	<p>15</p>  <p>84CR910R250 DAX R HANDLE FOR 250,690 &</p>	<p>16</p>  <p>84CR910579/956 DAX R HANDLE ONLY FOR 84CR579R579/956 KITCHEN MIXER</p>
<p>17</p>  <p>84BL910R579 DAX R HANDLE FOR 579 MIXER- BLACK</p>	<p>18</p>  <p>84CR910RS PAINI SMALL DAX R HANDLE</p>	<p>19</p>  <p>84CQ910RS DAX R SMALL HANDLE, BRUSHED NICKEL</p>	<p>20</p>  <p>84CR910 DAX COMPLETE HANDLE</p>

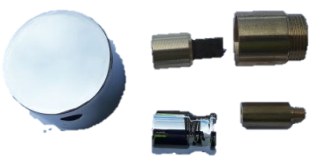

















<p>1</p>  <p>09CR910 NOVE HANDLE FOR 205, 205LL, 205SM, 306,</p>	<p>2</p>  <p>09CR910/111 NOVE HANDLE FOR 208,690,690SM,691,566, 568 ,570,572,573 CHROME</p>	<p>3</p>  <p>09CQ910 NOVE HANDLE FOR 205, 205LL, 205SM, 306, BRUSHED NICKEL</p>	<p>4</p>  <p>09CQ910/111 NOVEHANDLE FOR 208,690,690SM,691,566, 568,570,572,573 BRUSHED NICKEL</p>
<p>5</p>  <p>09BK910 NOVE HANDLE FOR 205, 205LL, 205SM, 306 BLACK</p>	<p>6</p>  <p>09BK910/111 NOVE HANDLE FOR 208,690,690SM,691,566, 568 ,570,572,573 BLACK</p>	<p>7</p>  <p>09GM910 NOVE HANDLE FOR 205, 205LL, 205SM, 306 GUN METAL</p>	<p>8</p>  <p>09GM910/111 NOVEHANDLE FOR 208,690,690SM,691,566, 568,570,572,573 GUN METAL</p>
<p>9</p>  <p>90CR910 LE MANS HANDLE CHROME</p>	<p>10</p>  <p>90CQ910 LE MANS HANDLE BRUSHED NICKEL</p>	<p>11</p>  <p>47CR910 PARALLEL HANDLE</p>	<p>12</p>  <p>47CR910 PARALLEL HANDLE</p>
<p>13</p>  <p>RGCR910/CEC CUCINA COMPLETE COLD CERAMIC HANDLE FOR 64CR544</p>	<p>14</p>  <p>RGCR910/CEH CUCINA COMPLETE HOT CERAMIC HANDLE FOR 64CR544</p>	<p>15</p>  <p>81CR9108X2078 PIXEL/COX COMPLETE HANDLE</p>	<p>16</p>  <p>WWCR910 ATACAMA LEVER</p>
<p>17</p>  <p>78CR910L2PBC COX PLUS LEVER - FEMALE</p>	<p>18</p>  <p>SHCR970 SMART MEDICAL LEVER ONLY</p>	<p>19</p>  <p>45CR970 CLINIC LEVER FOR 69CR205</p>	<p>20</p>  <p>53CR970 CLINIC LEVER FOR 42CR205</p>











<p>1</p>  <p>89CR910 LADY HANDLE CHROME</p>	<p>2</p>  <p>42CR910P9 AQUA MINIMAL HANDLE CHROME</p>	<p>3</p>  <p>42CR910 STD AQUASANIT (CRETA) HANDLE CHROME</p>	<p>4</p>  <p>67CR910PRB ATOMIX HANDLE W/DOTS</p>
<p>5</p>	<p>6</p>	<p>7</p>	<p>8</p>
<p>9</p>	<p>10</p>	<p>11</p>	<p>12</p>
<p>13</p>	<p>14</p>	<p>15</p>	<p>16</p>
<p>17</p>	<p>18</p>	<p>19</p>	<p>20</p>



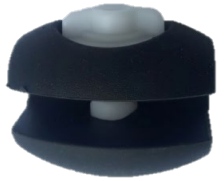

<p>1</p>  <p>78CR952 COX, LE MANS, PARALLEL, NOVE STANDARD FACEPLATE CHROME</p>	<p>2</p>  <p>78CQ952 COX, NOVE STANDARD FACEPLATE BRUSHED NICKEL</p>	<p>3</p>  <p>78BK952 COX, NOVE STANDARD FACEPLATE BLACK</p>	<p>4</p>  <p>78GM952 COX, LE MANS, PARALLEL, NOVE STANDARD FACEPLATE GUN METAL</p>
<p>5</p>  <p>78BB952 COX STANDARD FACEPLATE BRUSHED BRASS</p>	<p>6</p>  <p>78CR208RO COX, NOVE, PARALLEL, SMALL FACEPLATE CHROME</p>	<p>7</p>  <p>78CQ208RO COX, NOVE SMALL FACEPLATE BRUSHED NICKEL</p>	<p>8</p>  <p>78BK208RO COX, NOVE SMALL FACEPLATE BLACK</p>
<p>9</p>  <p>78GM208RO COX, NOVE SMALL FACEPLATE GUN METAL</p>	<p>10</p>  <p>78BB208RO COX, NOVE SMALL FACEPLATE BRUSHED BRASS</p>	<p>11</p>  <p>69CR952 STANDARD AQUASANIT FACEPLATE CHROME8bb208r</p>	<p>12</p> 
<p>13</p>  <p>5TCR953N SQUARE FACEPLATE WITH WASHER</p>	<p>14</p>  <p>27CR953THN SQUARE FACEPLATE WITH WASHER</p>	<p>15</p>  <p>78CR9530 PAINI COX / LE MANS DIVERTER FACEPLATE - SMALL</p>	<p>16</p>  <p>81CR952 PIXEL STD FACEPLATE FOR 81CR690 OUTSIDE EDGE IS 95MM</p>
<p>17</p>  <p>86CR952 OVO PLATE FOR 690</p>	<p>18</p>  <p>86CR953 OVO PLATE FOR 691</p>	<p>19</p>  <p>82CR952N DAX R / CRUX / LADY FACE PLATE NO WRITING ON FACEPLATE</p>	<p>20</p>  <p>82CR953N DIVERTER FACE PLATE ONLY WITH WRITING 82CR953 DIVERTER FACE PLATE ONLY NO WRITING</p>







<p>1</p>  <p>57CR211ZRE DAX R SQUARE BASE RING</p>	<p>2</p>  <p>78CR579RO BASE RING ONLY FOR COX, LE MANS, PARALLEL, OVO 205, 211, 572, 572SQ, 566, 568, 570, 573, 579,591,591LL, 591LS 64CR544</p>	<p>3</p>  <p>84CR579RR DAX R BASE PLATE FOR 84CR579R (ROUND WITH O RING)</p>	<p>4</p>  <p>84CR204RRO PAINI SMALL DAX R BASE RING</p>
<p>5</p>  <p>69CR954 COX SHOWER MIXER COLLAR CHROME COX / AQUASANT</p>	<p>6</p>  <p>RAN8X4X0 PAINI SILVER RING FOR 78CC956 BRASS BUSH</p>	<p>7</p>  <p>84CR430RPI DAX R FACEPLATE ONLY FOR 84CR430R</p>	<p>8</p>  <p>29CR901A CHROME FLANGE FOR 78CR400</p>
<p>9</p>	<p>10</p>	<p>11</p>	<p>12</p>
<p>13</p>	<p>14</p>	<p>15</p>	<p>16</p>
<p>17</p>	<p>18</p>	<p>19</p>	<p>20</p>

<p>1</p>  <p>78CC957 COX FIXING KIT FOR 78CR205/211</p>	<p>2</p>  <p>78CC957/572 COX FIXING KIT FOR 78CR572/42CR211</p>	<p>3</p>  <p>TIRFZ282 PAINI LONG FIXING SCREW FOR 211LL</p>	
<p>5</p>  <p>TIRFZ220 PAINI LONG FIXING SCREW FOR 78CR579</p>		<p>6</p>  <p>53CC957/566 FIXING SET FOR A 78CR591F4MT WITHOUT BIG BRASS FIXING</p>	<p>7</p>  <p>64TO566CAN BRASS FIXING MALE FOR 78CR591 (FIXING TUBE FOR 566)</p>
<p>8</p>  <p>GU1/2R WASHER WITH STRAINER 1/2"</p>	<p>9</p>  <p>VL1182 PAINI GRUB SCREW FOR SPOUT FOR 64CR544</p>	<p>10</p>  <p>64TO566TIR BRASS FIXING FEMALE FOR 78CR591 (FIXING NUT FOR 566)</p>	<p>11</p>  <p>81CR924I PAINI DIVERTER BUTTON ONLY FOR THE DAX R SHOWER MIXER AND PIXEL</p>
<p>12</p>  <p>78CR691P EXTENSION KIT PAINI WALL MIXERS 25mm OLD STYLE INCL. DIVERTER EXTENSION</p>	<p>13</p>  <p>78CR690P1 CHROME 78CQ690P1 BRUSHED NICKEL PAINI 40MM EXTENSION KIT FOR SHOWER VALVES -</p>	<p>14</p>  <p>69/573GACO LIP SEAL (EA) FOR SWIVELING SPOUTS 78CR573/579/568/42CR57 2 USUALLY REQUIRED</p>	<p>15</p>  <p>81CR924B PIXEL DIVERTER BUTTON ASSEMBLY FOR 81CR691</p>
<p>16</p>  <p>79CC907 TUBOS / COX EXTENSION (ONE X 15MM)</p>	<p>17</p>  <p>79CC10INS TUBOS PLASTIC SPINDLE SPLINE - HEAT INSULATER</p>	<p>18</p>  <p>84TO956RR DAX-R GRUB SCREW FOR CARTRIDGE (BRASS NIPPLE ON CARTRIDGE FOR 84CR579R)</p>	<p>19</p>  <p>53CC947SET CRETA BASIN LEVER INDICATOR53N</p>

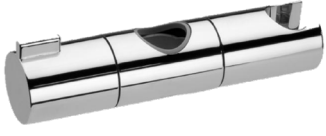
<p>1</p>  <p>53CR913A6 EXTENDED HORIZONTAL POP UP</p>	<p>2</p>  <p>53CR912 COX POP UP PLUG ONLY 40MM DIA</p>	<p>3</p>  <p>64CR566T SOLID TAIL FOR 78CR591 FLEXI66T</p>	
<p>4</p>  <p>20CR691DM DIVERTER BUTTON ASS FOR 78CR691 & 69CR691,90CR691, 86CR691</p>	<p>5</p>  <p>54CR945FCH PAINI WASTE COMES WITH VERICAL ROD AND JOINER</p>	<p>6</p>  <p>84CR597 DAX BASIN MIXER SPOUT ONLY (84CR250)</p>	<p>7</p>  <p>78CR579CAN COX SPOUT ONLY</p>
<p>8</p>  <p>84CR572CAN COX SPOUT ONLY</p>	<p>9</p>  <p>78CR591CAN COX SPOUT ONLY</p>	<p>10</p>  <p>53CR599/544 TUBE SPOUT FOR CUCINA</p>	<p>11</p>  <p>78CR572CAN COX SPOUT ONLY</p>
<p>12</p>  <p>53CR682A AERATOR FOR PAINI BASIN MIXER M 24</p>	<p>13</p>  <p>53CR682D AERATOR 16MM (FOR 78CR573 AND 89CR205)</p>	<p>14</p>  <p>53CR682E COX SMALL BASIN AERATOR PAINI PIXEL AERATOR CHROME</p>	<p>15</p>  <p>81G5682E8/0 PAINI AERATOR FOR 09CR205 (INNER PART ONLY)</p>
<p>16</p>  <p>78CR682B COX AERATOR 22X1F</p>	<p>17</p>  <p>78CR682B1/O FLOW RESTRICTOR FOR COX 3.8L/MIN</p>	<p>18</p>  <p>53CC682AIN1/2 PAINI 4.5 L/M AERATOR 24X1M 78CR205 78CR430 78CR572 etc</p>	<p>19</p>

<p>1</p>  <p>53CR573T END OF 78CR573 KITCHEN MIXER SPOUT INCLUDES AERATOR</p>	<p>2</p>  <p>53CC975/17/96 RUBBER ORING FOR 572 ROUND SPOUT</p>	<p>3</p>  <p>OR104 RUBBER ORING FOR HANDLE STEM ON A 78CR910</p>	<p>4</p>  <p>GU14X8 O RING FOR 78CR591 PULL OUT HOSE</p>
<p>5</p>  <p>GRAN04X3 SMALL GRUB SCREW FOR 81CR211 HANDLE AND PIXEL SHOWER MIXER HANDLE</p>	<p>6</p>  <p>GRAN05X16 THREADED GRUB SCREW FOR A 78CR910 HANDLE (OLD)USE GRAN05X8 ****DISCONTINUED****</p>	<p>7</p>  <p>GRAN05X8 FIXING SCREW FOR PAINI SHOWER & BASIN MIXER HANDLE</p>	<p>8</p>  <p>53NR587P10G PAINI RUBBER WEIGHT 450GR FOR RETRACTABLE KITCHEN HOSE</p>
<p>9</p>  <p>53G5947SIL SILICON GRUB SCREW CAP FOR HANDLE</p>	<p>10</p>  <p>56YO947TN BLACK GRUB SCREW CAP FOR HANDLE</p>	<p>11</p>  <p>56CR947TN CHROME GRUB SCREW CAP FOR HANDLE</p>	<p>12</p>
<p>13</p>	<p>14</p>	<p>15</p>	<p>16</p>
<p>17</p>	<p>18</p>	<p>19</p>	<p>20</p>

<p>1</p>  <p>P2SLIDER SLIDER FOR P2</p>	<p>2</p>  <p>53G5164C175 FLEXI HOSE FOR P2, 175 CM</p>	<p>3</p>  <p>53CR163DAC200 PAINI METAL SHOWER HOSE 2 METRE</p>	<p>4</p>  <p>53CR155/P2 PAINI HAND SHOWER ONLY FOR P2</p>
<p>5</p>  <p>AM100 P2 CHROME SOAP DISH AND INSERT</p>	<p>6</p>	<p>7</p>	<p>8</p>
<p>9</p>	<p>10</p>	<p>11</p>	<p>12</p>
<p>13</p>	<p>14</p>	<p>15</p>	<p>16</p>
<p>17</p>	<p>18</p>	<p>19</p>	<p>20</p>

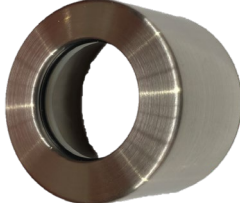
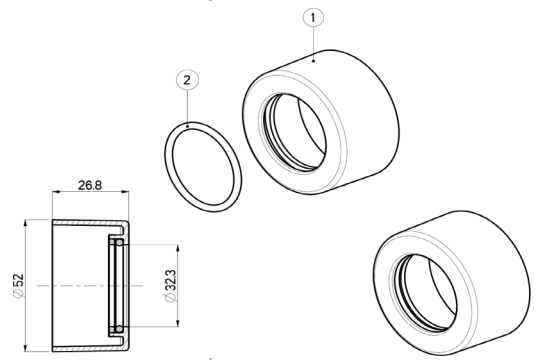
<p>1</p>  <p>86005TME NIKLES MECHANISM TWIST 24MM TECHNO CHROME SHOWER SLIDER</p>	<p>2</p>  <p>76005ME COMPLETE SLIDER ASSEMBLY FOR TECHNO 19MM RAIL</p>	<p>3</p>  <p>2985F/DF WALL ELBOW METAL MINIMAL WITH NON RETURN VALVE</p>	<p>4</p>  <p>H1055 WALL ELBOW METAL MINIMAL WITH NON RETURN VALVE</p>
<p>5</p>  <p>J77005M TECHNO FIXING KITS INCL END CAPS FOR 18MM RAIL</p>	<p>6</p>  <p>JA61031705M UPPER FLANGE JA59030105M LOWER FLANGE FOR MX200CH CHROME</p>	<p>7</p>  <p>JA61031705M UPPER FLANGE JA59030105M LOWER FLANGE FOR MX200BK MATT BLACK</p>	<p>8</p>  <p>JA61031705M UPPER FLANGE JA59030105M LOWER FLANGE FOR MX200BN BRUSHED NICKEL</p>
<p>9</p>	<p>10</p>	<p>11</p> 	
<p>12</p>	<p>13</p>	<p>14</p>	<p>15</p>
<p>16</p>	<p>17</p>	<p>18</p>	<p>19</p>

1

AT90651 10-20 sec
SILFRA CARTRIDGE FOR QUIK
QK230, QK235, QK240
BASIN TAP

2

AC90851 20-25 sec
SILFRA CARTIDGE FOR QUIK
WALL MOUNTED EXTERNAL
SHOWER QK160,QK165

3

AT90151 5-10 sec
SILFRA CARTIDGE FOR QUIK
EXTERNAL URINAL VALVE
QK100,QK105

4

AT90551 20-25 sec
SILFRA CARTIDGE FOR QUIK
CONCEALED SHOWER VALVE
QK150

5

AT97151 5-10 sec
SILFRA CARTIDGE FOR QUIK
CONCEALED URINAL VALVE
QK110

6

AT910 15-20 sec
SILFRA CARTIDGE FOR QUIK
CLINIC BASIN TAP
QL230, QL235

7

AT97651 15 sec
SILFRA CARTIDGE FOR QUIK 4
BASIN TAP
Q4230,Q4232

8

AT97751 15 sec
SILFRA CARTIDGE FOR QUIK 4
BASIN TAP
Q4250,Q4265

9

AT97851 30 sec
SILFRA CARTIDGE FOR QUIK 4
EXTERNAL SHOWER VALVE
Q4160,Q4165

10

AT97951 8 sec
SILFRA CARTIDGE FOR QUIK 4
EXTERNAL URINAL VALVE
Q4100,Q4105

11

AT98051 30 sec
SILFRA CARTIDGE FOR QUIK 4
CONCEALED SHOWER VALVE
Q4150,Q4152

12

AT98151 30 sec
SILFRA CARTIDGE FOR QUIK 4
CONCEALED SHOWER VALVE
Q4110

13

AT936 10 -20 sec
SILFRA CARTIDGE FOR QUIK 5
BASIN TAP
Q5230,Q5235,Q5240

14

AT938 20 -25 sec
SILFRA CARTIDGE FOR QUIK 5
EXTERNAL SHOWER VALVE
Q5160,Q5165

15

AT931 5 -25 sec
SILFRA CARTIDGE FOR QUIK 5
EXTERNAL URINAL VALVE
Q5100,Q5105

16

AT90551 20 -25 sec
SILFRA CARTIDGE FOR QUIK 5
CONCEALED SHOWER VALVE
Q5150

17

AT97151 5 -10 sec
SILFRA CARTIDGE FOR QUIK 5
CONCEALED URINAL VALVE
Q5110





18





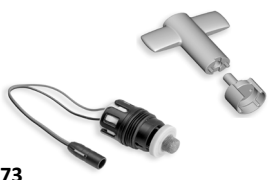

AT900
RED INDICATOR FOR TIMER TAPS

19

CRIRI21551
SILFRA FACEPLATE ONLY FOR
Q5110
CHROME









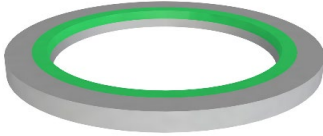









20

<p>1</p>  <p>QT955 SILFRA BATTERY STABILIZER FOR QT RANGE</p>	<p>2</p>  <p>QT986 SILFRA BATTERY CR-P2 LITHIUM 6V FOR QT992</p>	<p>3</p>  <p>QT973 SOLENOID FOR QT330, QT332, QT338, QT339, QT860, QT862, QT868, QT869, QT870, QT872, QT878, QT879, QT820, QT828</p>	<p>4</p>  <p>AT870 WRENCH FOR CARTRIDGE RAW</p>
<p>5</p> <p>VG0419D00 FIXING SCREW FOR CONCEALED URINAL AND SHOWER VALVES</p>	<p>6</p>	<p>7</p>	<p>8</p>
<p>9</p>	<p>10</p>	<p>11</p>	<p>12</p>
<p>13</p> <p style="text-align: center;">÷</p>	<p>14</p>	<p>15</p>	<p>16</p>
<p>17</p> <p style="text-align: center;">÷</p>	<p>18</p>	<p>19</p>	<p>20</p>

<p>1</p>  <p>RI04351 06 ABS ROUND HANDLE ONLY</p>	<p>2</p>  <p>AS11051 06 COVER RING FIXING FLANGE</p>	<p>3</p>  <p>RI13051 ABS OVAL HANDLE + 5CM</p>	<p>4</p>  <p>RI00551 PLUG 42MM SILFRA DOME</p>
<p>5</p>  <p>RI03851 PLUG 72MM ABS DOME SILFRA DOME ABS DIAMETER 72MM FOR BATH</p>	<p>6</p>  <p>RI00651 PLUG 72MM SILFRA DOME METAL BATH</p>	<p>7</p>  <p>VG2990P00 SCREW FOR SILFRA BATH WASTE PLUG 06 WASTE</p>	<p>8</p>
<p>9</p>	<p>10</p>	<p>11</p>	<p>12</p>
<p>13</p>	<p>14</p>	<p>15</p>	<p>16</p>
<p>17</p>	<p>18</p>	<p>19</p>	<p>20</p>

















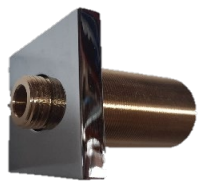

<p>1</p>  <p>RI07151 BRASS PLUG UP&DOWN FOR UD38951 ONLY 64MM DIAMETER PLUG</p>	<p>2</p>  <p>RI285 REPLACEMENT TOP CERAMIC PART FOR WA 820 WHITE CLICK CLACK</p>	<p>3</p>  <p>RI08051 SILFRA CR/BRASS DRESS CYLINDER</p>	<p>4</p>
<p>5</p>	<p>6</p>	<p>7</p>	<p>8</p>
<p>9</p>	<p>10</p>	<p>11</p>	<p>12</p>
<p>13</p>	<p>14</p>	<p>15</p>	<p>16</p>
<p>17</p>	<p>18</p>	<p>19</p>	<p>20</p>













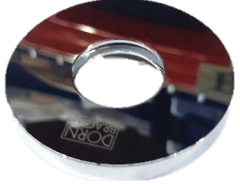

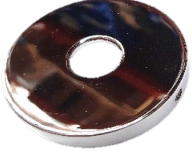



<p>1</p>  <p>B0632OC30B7 BOTTLE TRAP EXTENSION INLET/OUTLET 32MM X 250 MM LONG</p>	<p>2</p>  <p>B0632OT30B7 BOTTLE TRAP EXTENSION OUTLET 32X300</p>	<p>3</p>  <p>GU2200 FLAT WASHER FOR 32MM BOTTLE TRAP</p>	<p>4</p>  <p>RS0952 32MM BOTTLE TRAP WALL FLANGE</p>
<p>5</p>	<p>6</p>	<p>7</p>	<p>8</p>
<p>9</p>  <p>V370 VALENTIN GRILLE FOR V5710</p>	<p>10</p>	<p>11</p>	<p>12</p>
<p>13</p>	<p>14</p>	<p>15</p>	<p>16</p>
<p>17</p>	<p>18</p>	<p>19</p>	<p>20</p>



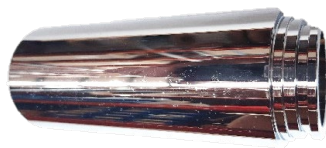

<p>1</p>  <p>R38140023 TOILET BRUSH HEAD ONLY FOR V814 / 3814 / 8314 / 5814 / 0414 / 4614 / 0514 LAPARI / TOUCH (HAS GRUB SCREW)</p>	<p>2</p>  <p>R03290001 SPRING LOADED HOLDER CHROME ROLLER ALSO FIT DIVO RANGE</p>	<p>3</p>  <p>R38140018 INDA PLASTIC INSERT FOR BOTTOM OF 3814/8314 TOILET</p>	<p>4</p>  <p>R46110 TOUCH / LOGIC, MITO, ELLIPI SPARE SOAP DISH</p>
<p>5</p>  <p>R38140 SPARE BRUSH & HANDLE FOR 3814 / 8314</p>	<p>6</p>  <p>R46140 TOUCH SPARE BRUSH SET</p>	<p>7</p>  <p>RV8140 SPARE BRUSH & HANDLE FOR V814</p>	<p>8</p>  <p>R76140001 FORUM BRUSH WITH HANDLE</p>
<p>9</p>  <p>R76140002 FORUM BRUSH HEAD ONLY</p>	<p>10</p>  <p>R76140 FORUM GLASS BOWL FOR TOILET BRUSH</p>	<p>11</p>  <p>RV014A003 MAI LOVE BRUSH AND HANDLE WHITE</p>	<p>12</p>  <p>RV014A009 MAI LOVE CUP WHITE</p>
<p>13</p>  <p>RV0140001 MAI LOVE BRUSH WHITE</p>	<p>14</p>  <p>RV014B003 MAI LOVE BRUSH BLACK</p>	<p>15</p>  <p>RV014B004 MAI LOVE CUP BLACK</p>	<p>16</p>  <p>RV014B MAI LOVE BRUSH BLACK</p>
<p>17</p>	<p>18</p>	<p>19</p>  <p>R761200001 SOAP PUMP FOR FORUM</p>	<p>20</p>  <p>R01060001 SOAP PUMP=TOUCH-H2O-SMILE-FIFTIES</p>

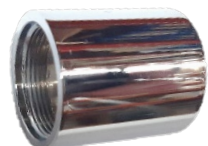









<p>1</p>  <p>EA130011 ALMAR COVER FOR WALL BRACKET FOR AL03 TOP, AL04 TOP & BOTTOM, CHROME AVAILABLE IN BRUSHED NICKEL ADD BN TO CODE</p>	<p>2</p>  <p>EA089012 ALMAR RECTANGLE CAP, AL01 & AL03 BOTTOM BRACKET, CHROME</p>	<p>3</p>  <p>EA014033 ALMAR FIXING BRACKET WHITE PLASTIC (AL03 TOP AND AL04 TOP & BOTTOM)</p>	<p>4</p>  <p>EA014032 ALMAR WALL BRACKET WITH WATER OUTLET FOR AL01 & AL03, WHITE PLASTIC</p>
<p>5</p>  <p>E003027 ALMAR WATER INLET BRASS PART ONLY</p>	<p>6</p>  <p>E003030 ALMAR INTERNAL TOP FIXING KIT FOR AL01</p>	<p>7</p>  <p>EA130010 ALMAR COVER FOR BRACKET WITH WATER INLET FOR AL01, AL03 CHROME</p>	<p>8</p>  <p>E095014 ALMAR EMOTION WATER ELBOW FOR AL02, AL04 & AL14 AVAILABLE IN BRUSHED NICKEL ADD BN TO CODE</p>
<p>9</p>  <p>E108012 ALMAR SLIDER D20 CHROME AVAILABLE IN BRUSHED NICKEL ADD BN TO CODE</p>	<p>10</p>  <p>E091003 ALMAR NON RETURN VALVE FOR ALMAR HANDSHOWER</p>	<p>11</p>  <p>E003079 ALMAR DIVERTER KIT FOR SHOWER COLUM SPARE PART</p>	<p>12</p>  <p>E082035 ALMAR SHUT OFF SHOWER CHROME (BIDET HANDPIECE)</p>
<p>13</p>  <p>E120007 ALMAR WALL BRACKET ALSO AVAILABLE BRUSHED NICKEL ADD BN TO CODE</p>	<p>14</p>  <p>E095010 ALMAR SQUARE WATER OUTLET WITH HOLDER</p>	<p>15</p>  <p>E095005BN ALMAR ROUND WATER OUTLET, BRUSHED NICKEL</p>	<p>16</p>  <p>E095008 ALMAR ELBOW WITH HOLDER ROUND FLANGE COLOURS CHROME, BRUSHED NICKEL, BLACK</p>
<p>17</p>  <p>C084023 ALMAR SILVER FLEX CHROME WIDE BORE 150CM HOSE</p>	<p>18</p>  <p>E084021 ALMAR SILVER FLEX HOSE 150CM</p>	<p>19</p>  <p>E084034BN ALMAR BRUSHED NICKEL HOSE 1,5M FOR AL03BN & AL04BN E084035BN ALMAR BRUSHED NICKEL HOSE 2 M FOR AL01BN & AL02BN</p>	<p>20</p>  <p>E003040 ALMAR TOP CURVED PART FOR AL01-2</p>

<p>1</p>  <p>D9015050300090 META 02 SHOWER AND CARTRIDGE MOST RANGES I.E. TARA/ META. MOST BASIN & KITCHEN MIXER (OLD CODE D0315050300090) 35MMS</p>	<p>2</p>  <p>D9015050420090 CARTRIDGE FOR IMO & GENTLE 115MM PROJECTION BASIN MIXER</p>	<p>3</p>  <p>D9015050200090 META PUR SHOWER CARTRIDGE FOR PRE 2003 META PUR SHOWER MIXER (D3500597090 & D3510597090)</p>	<p>4</p>  <p>D09150505090 DORN X STREAM CARTRIDGE</p>
<p>5</p>  <p>D09150506190 DORNBRACHT CARTRIDGE FOR ELIO, SUPERNOVA MIXER</p>	<p>6</p>  <p>D09150504190 DORNBRACHT BASIN CARTRIDGE FOR META 02 / LULU</p>	<p>7</p>  <p>D09150506390 CARTRIDGE FOR TARA SINK MIXER META 02 KITCHEN MIXER BENCH MOUNT(CAN USE 53CC956GMD)</p>	<p>8</p>  <p>D041502063009 X TOOL THERMOSTAT CARTRIDGE WITH REGULATOR 1/2"</p>
<p>9</p>  <p>D0415020650090 X TOOL THERMOSTATIC CARTRIDGE</p>	<p>10</p>  <p>D9090032000090 DORNBRACHT HOT AND COLD CARTRIDGES (1 PAIR)</p>	<p>11</p>  <p>D9090031310009 1/2" HEADWORKS CW CLOSE SHORT</p>	<p>12</p>  <p>D909003130009 1/2" HEADWORKS ACW CLOSE RESTRICTED</p>
<p>13</p>  <p>D049003143009 1/2" CERAMIC HEAD PART, CLOCKWISE CLOSING</p>	<p>14</p>  <p>D049003156009 X CONTROL CERAMIC HEAD PART. ANTI-CLOCKWISE CLOSING 1/2"HOT SIDE (use code D9090031560090 when sold out)</p>	<p>15</p>  <p>D039003137009 DORN 1/2" CERAMIC HEAD VALVE ASSY</p>	<p>16</p>  <p>D0421340760090 DIVERTER FOR META PUR DIVERTER SHOWER MIXER</p>
<p>17</p>  <p>D0912120290 PLASTIC INSULATOR FOR CERAMIC HEADWORKS</p>	<p>18</p>  <p>D0924041121090 BRASS LOCKING NUT</p>	<p>19</p>  <p>D1286997090 DORNBRACHT 20MM EXTENSION FOR D3586097090 WALL & BASIN VALVE</p>	<p>20</p>  <p>D12161970 DORN WALL VALVE SPINDLES</p>

<p>1</p>  <p>D043011038669 META 02 KITCHEN MIXER FIXING KIT FOR HAND PIECE ONLY</p>	<p>2</p>  <p>D0430110380090 DORN HAUTE CUSINE FIXING KIT</p>	<p>3</p>  <p>D0423100440290 ELIO FIXING KIT</p>	<p>4</p>  <p>D0423100324690 META 02 KITCHEN MIXER FIXING KIT FOR MIXER ONLY</p>
<p>5</p>  <p>D0430110856290 DORN META 02 FIXING KIT</p>	<p>6</p>  <p>D0421021080090 DORN DIVERTER, AUTOMATIC</p>	<p>7</p>  <p>D041505000090 X STREAM CARTRIDGE FOR D35.905.970.90</p>	<p>8</p>  <p>D90277802300-00 DORNBRACHT ROSETTE, CHROME</p>
<p>9</p>  <p>D042403165010-07 NON RETURN VALVE FOR KITCHEN MIXERS WITH SEPARATE SPRAYS (INLINE)</p>	<p>10</p>  <p>D09290301090 STANDARD AERATOR FOR SYNC AND NEW TARA ULTRA KITCHEN MIXER (NOT FLOW)</p>	<p>11</p>  <p>D90230102607 DORN AERATOR FOR D33800790</p>	<p>12</p>  <p>D90230101900-00 DORNBRACHT META 02 AERATOR FOR WALL MOUNT SPOUT</p>
<p>13</p>  <p>D09311103890 DORNBRACHT GRUB SCREW</p>	<p>14</p>  <p>D09281016290 SYNC RING</p>	<p>15</p>  <p>D09281016190 SYNC RING</p>	<p>16</p>  <p>D09281016090 SYNC RING</p>
<p>17</p>  <p>D092810111FF MIXER ROSETTE FOR D32820625 / D32800625</p>	<p>18</p>  <p>D09160102690 DORN PLASTIC C CLIP</p>	<p>19</p>  <p>D09290603890 TARA EXTENSIONS</p>	<p>20</p>  <p>D09141503090 LOCKING NUT</p>

<p>1</p>  <p>D09141001090 ORING</p>	<p>2</p>  <p>D09281003090 ORING FOR DORNBRACHT KITCHEN MIXER TARA CLASSIC</p>	<p>3</p>  <p>D09141005590 ORING</p>	<p>4</p>  <p>D09141002690 META 02 SPOUT FLANGE ELBOW</p>
<p>5</p>  <p>D0927220039000 META 02 SPOUT FLANGE (REQUIRES ORING 09.14.10.026.90)</p>	<p>6</p>  <p>D0927220040 ROSETTE FOR CEILING ARM</p>	<p>7</p>  <p>D04233004000-00 HAUTE CUSINE DIVERTOR 20MM NIPPLE</p>	<p>8</p>  <p>D041211093000 HANDPIECE ONLY FOR D27719970</p>
<p>9</p>  <p>D1117088033 TARA CLASSIC LEVER ONLY MATT BLK</p>	<p>10</p>  <p>D11170370 MADISON FLAIR HANDLE INSERT CHROME</p>	<p>11</p>  <p>D09208900500 META PUR HANDLE STEM ONLY</p>	<p>12</p>  <p>D11170880-00 TARA CLASSIC HANDLES ONLY</p>
<p>13</p>  <p>D1117032500 BELLE DE BAIN HANDLE CP</p>	<p>14</p>  <p>D092080021 VAIA HANDLE, CHROME</p>	<p>15</p>  <p>D90208402000 LISSE HANDLE</p>	<p>16</p>  <p>D092822027-00 TARA LOGIC EXTENSION PIECE</p>
<p>17</p>  <p>D04208900301-00 TARA HANDLE **ITEM OUT OF DATE **</p>	<p>18</p>  <p>D092102070-00 COVER</p>	<p>19</p>  <p>D0924030811090 DORN SPOUT EXTENTION</p>	<p>20</p>

<p>1</p>  <p>D0424032410090 DORNBRACHT NON RETURN VALVE FOR KITCHEN MIXER SPRAY</p>	<p>2</p>  <p>D1163970 DOR WALL VALVE SPINDLE 40MM</p>	<p>3</p>  <p>D9024042910090 DORNBRACHT WALL CONNECTION</p>	<p>4</p>
<p>5</p>  <p>D09300128500 DORNBRACHT ROUND SUPPORT FOR KITCHEN HAND SPRAY D27721970, CHROME</p>	<p>6</p>  <p>D091110062-00 META 02 SPOUT BASE</p>	<p>7</p>  <p>D091110062-06 META 02 SPOUT BASE MATT PLATT</p>	<p>8</p>
<p>9</p>	<p>10</p>	<p>11</p>	<p>12</p>
<p>13</p>	<p>14</p>	<p>15</p>	<p>16</p>
<p>17</p>	<p>18</p>	<p>19</p>	<p>20</p>

<p>1</p>  <p>D091102260-00 SLEEVE FOR D36120979</p>	<p>2</p>  <p>D0914100499 META02 O-RING FOR ROUND FACEPLATE</p>	<p>3</p>  <p>D90282204902 TARA CLASSIC HOOP SPOUT 235MM - SPOUT ONLY CHROME</p>	<p>4</p>  <p>D90282218600 ELIO SPOUT ONLY FOR</p>
<p>5</p>  <p>D90282218500-00 DORNBRACHT SPOUT ONLY FOR ELIO D33826790</p>	<p>6</p>  <p>D902822150000 MEM SPOUT ONLY</p>	<p>7</p>  <p>D90282204900-06 235MM PROJECTION HOOP SPOUT -</p>	<p>8</p>  <p>D90282204900-00 235MM PROJECTION HOOP</p>
<p>9</p>  <p>D90282204800-06 200MM PROJECTION HOOP</p>	<p>10</p>  <p>D04282211710FF META 02 SPOUT ONLY 250MM</p>	<p>11</p>  <p>D04240204601 10MM RIDGID TAILS</p>	<p>12</p>
<p>13</p>	<p>14</p>	<p>15</p>	<p>16</p>
<p>17</p>	<p>18</p>	<p>19</p>	<p>20</p>

<p>1</p>  <p>VR277 VOLA CARTRIDGE FOR HV1 BASIN AND KITCHEN MIXERS & 111 WALL MOUNT MIXER</p>	<p>2</p>  <p>VR1277 VOLA CARTRIDGE FOR 2200V FOR SHOWER MIXERS</p>	<p>3</p>  <p>VR090 VOLA SERVICE SET FOR 090 KV1</p>	<p>4</p>  <p>VR030 VOLA ORING & LUBE KIT</p>
<p>5</p>  <p>VR31 VOLA ORING FOR 090 / KV1 SPOUT</p>	<p>6</p>  <p>VR273 VOLA SHORT LEVERS</p>	<p>7</p>  <p>VR273L VOLA LEVER - LONG FOR 200V HV1, KV1</p>	<p>8</p>  <p>VR273M VOLA LEVER - MEDIUM FOR 200V</p>
<p>9</p>  <p>VR1260+ VR2260+</p> <p>BASIN MIXER SHOWER MIXER</p> <p>VR269 VR2269</p>			
<p>10</p> <p>VR1260 VOLA WALL MOUNTED BASIN MIXER EXTENSIONS VR1260 + 10 10MM VR1260 + 20 20MM VR1260 + 30 30MM VR1260 + 40 40MM</p>	<p>11</p> <p>VR2260 VOLA WALL MOUNTED SHOWER MIXER EXTENSIONS VR2260 + 10 10MM VR2260 + 20 20MM VR2260 + 30 30MM VR2260 + 40 40MM</p>	<p>12</p> <p>VR2119 VOLA WALL MOUNTED SPOUT COLLAR EXTENSIONS VR2119 + 10 10MM VR2119 + 20 20MM VR2119 + 30 30MM VR2119 + 40 40MM</p>	<p>13</p> <p>VR2019 VOLA WALL MOUNTED SPOUT COLLAR EXTENSIONS VR2019 + 10 10MM VR2019 + 20 20MM VR2019 + 30 30MM VR2019 + 40 40MM</p>
<p>14</p>	<p>15</p>	<p>16</p>	<p>17</p>



K6897
KALDEWEI SEALING KIT FLEX FOR
BATHS
5 METER SEALING TAPE, 2 WALL
CORNER PIECES

1	2	3	4
5	6	7	8
9	10	11	12
13	14	15	16
17	18	19	20